

GOVERNMENT OF THE DEMOCRATIC SOCIALIST REPUBLIC OF SRI LANKA

MINISTRY OF HIGHWAYS

ROAD DEVELOPMENT AUTHORITY

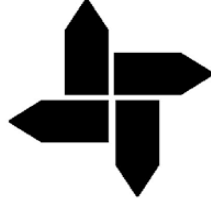

REGISTERED SUPPLIERS FOR YEAR 2022

GOODS AND SERVICES

Procurement Division, Road Development Authority, 4th Floor, "Maganeguma Mahamedura",
Denzil Kobbekaduwa Mawatha, Koswatta, Battaramulla
Tel: 0112884790 / 0112046475 / 0112046482
E Mail : rdaprocurment@gmail.com / procurment@rda.gov.lk



මාර්ග සංවර්ධන අධිකාරිය
வாதி அபிவிருத்தி அதிகாரசபை
Road Development Authority

“මගනෙගුම මහ මැදුර”, දෙන්සිල් කොබ්බදාව මාවත,
කොස්වත්ත, බත්තරමුල්ල, ශ්‍රී ලංකාව.

“மகநெகும மஹமெதுர்” டென்சில் கொப்பேகடுவ மாவத்தை,
கொஸ்வத்தை, பத்தரமுல்லை, இவங்கை.

"Maganeguma Mahamedura", Denzil Kobbedaduwa Mawatha,
Koswatta, Battaramulla, Sri Lanka.

Additional Director Generals
Directors
Deputy Directors
Project Directors
Provincial Directors
Chief Engineers
Executive Engineers
Officers in charge of the Plants
Chief Stores Liaisons Officer

මගේ අංකය
எனது இல. } RDA/DPR/RS2022/2021/134
My No. }
ඔබේ අංකය
உமது இல. }
Your No. } 28th February 2022
දිනය
திகதி }
Date }

Registration of Suppliers for the Goods and Service Providers for Year 2022
Road Development Authority

Attached herewith is the publication developed by the Procurement Division, comprising the list of suppliers for goods and service providers registered with the Road Development Authority. The document has been segregated into two categories as per the organization requirements under the basis indicated below.

- Category 1.** The supply of Goods
Category 2. The Supply of General Services

The Organizations and Individuals listed herein have agreed for surcharging Rs. 1000.00 each, at occurrence of the following incidents and to the deletion of their names from the list of potential suppliers, if below noted events occur three times.

- Unable to provide the Goods, Material or Services within the time period indicated in the Purchase Order.
- Unable to respond for the quotations invited on three occasions consecutively.
- Delivered goods, material, services and the samples submitted are below or not complying with the standards specified, or the quality anticipated.

You are requested to inform the Director Procurement, details of the Organizations and Individuals who have more than three of the above incidents for the purpose of monitoring and to take suitable action securing the Organization's interest. This list of the registered suppliers is valid till 28th February 2023 to obtain the necessary goods and services for the Road Development Authority while exercising the procedure spelled out at the Procurement Guide Lines in the Country.

Director General
Road Development Authority

Telephones:-

Chairman 2862767, Director General 2862795, Working Director 2887257, General Number ++94-11-2046200
Additional Director Generals {Projects 2862485, AO&M 2864804, CD 2882194, NP 2886923}
Directorates {Administration 2865245, Construction 2864388, Engineering Services 2864803, EO&M 038-2291373, ESD 2187165
Finance 2864799, Highway Designs 2874024, Internal Audit 2872661, Lands 2889350 Legal 2186044, Mechanical 2872273
MM 2882196, Planning 2882995, Procurement 2886863, QA&PM 2887235, R&D 2632649 Rural Bridges 2623896, Training 2869342}

CONTENT

1.0) SUPPLY OF GOODS

Page No

1.1	Binding Machines.....	1
1.2	CCTV Cameras.....	2 -5
1.3	Computer Stationery (Toners, Cartridges, Ink Ribbons, Master rolls etc).....	6 - 15
1.4	Computers & Peripheral equipment.....	16 -23
1.5	Convertainer Boxes.....	24
1.6	Drawing and Design equipment.....	25
1.7	Drinking Water bottles.....	26
1.8	Electrical Equipment & Accessories (Air-Conditioners, Fans, Televisions, Cables etc)...	27 - 31
1.9	Electronic Equipment (Finger Print/CashCounting/POS Machines, Barcode readers)....	32 - 35
1.10	Facsimile, Telephones, Calculator & Communication equipment.....	36 - 37
1.11	Gate Controller Units & Power supply units / Loop sensors.....	38
1.12	Laboratory material, Tools, Accessories, Chemicals and Hardware items.....	39 - 41
1.13	LED Street lights, Road lanterns, Light poles etc.....	42 - 45
1.14	Money Detectors etc.....	Not Reg
1.15	Office Furniture (Wooden, Steel & Plastic).....	47-49
1.16	Office Stationery & Consumables.....	50 -54
1.17	Photocopy and Printing Machines.....	55- 58
1.18	Photocopy Papers, Thermal paper rolls.....	59 - 60
1.19	Plants/ Fertilizers.....	61
1.20	Spare Parts – Construction Equipment & Machinery.....	62 - 63
1.21	Spare parts - Electronic Equipment.....	Not Reg
1.22	Spare Parts - Motor Cycle.....	65
1.23	Spare parts - Motor Launches including Marine Engines & out Board Motors.....	66
1.24	Spare Parts - Motor Vehicle.....	67 68
1.25	Spare Parts - Used and serviceable spare parts for vehicles and machinery.....	69 - 70
1.26	Surveying and Leveling equipment.....	71 -72
1.27	Sweeper Brushes.....	73
1.28	Tracing, Plotter Papers.....	74
1.29	Tyres, Tubes, Flaps and Batteries for vehicles and machinery.....	75 - 80
1.30	Uniform Items (Shoes, Slippers, Boots, Rain Coats, Bags, Brief Cases etc).....	81 -82
1.31	Uniform Materials (Trouser, Shirting, Sarong, Saree, Labour Jackets etc).....	83 - 84
1.32	Water Boilers.....	85
1.33	Workshop Equipment and tools.....	86 - 87
1.34	Workshop Hardware - Grinding discs, hacksaw blades and Sand papers etc.....	88 - 89
1.35	Workshop Hardware - Machine tools, Jumper and High Speed Steel etc.....	90 - 91
1.36	Workshop Hardware - Non ferrous metal (Aluminum, Brass and Bronze etc.....	92
1.37	Workshop Hardware - PVC tubes, Poly ethylene & Polypropylene Products.....	93 - 94
1.38	Workshop Hardware – Steel, angle iron, channels, bars, tubes & sheet metals.....	95 - 96
1.39	Workshop Hardware - Welding equipment and electrodes.....	97 - 98
1.40	Traffic Safety Equipment’s (cones, Gloves, Boots, Helmets, etc).....	99 - 100
1.41	Health and Safety Material and Equipment (Sanitizer, Marks, and Thermometers etc.)...	101 - 102
1.42	Others.....	103

2.0) SUPPLY OF SERVICE

2.1 Auto electrical & Maintenance Including AC Audio.....	104
2.2 Building repairs, Plumbing, Carpentry etc.....	105 - 106
2.3 Data, Voice Wiring / Networking.....	107 - 109
2.4 Electrical Wiring & Repairs.....	110 - 111
2.5 Generator Services & Maintenance.....	112 - 113
2.6 Indoor AC Units Service & Maintenance.....	114 - 115
2.7 Labour Contracts on Tinkering & Painting or Outsourced Works.....	116 - 117
2.8 Maintenance and Repair – Engine Overhauls and Related Machine Works.....	118 -123
2.9 Maintenance & Repair – Injector Pumps.....	124
2.10 Maintenance of Tolling System.....	Not Reg
2.11 Motor Vehicle Oil Changes, Servicing and Interior Cleaning Works.....	126 - 131
2.12 Office Cleaning.....	132
2.13 Office Renovation (Aluminum Partitioning, Interior & Related Works).....	133
2.14 Photographic Processing and Provide Identity Cards.....	134
2.15 Printing Works.....	135 - 138
2.16 Rebuilding of Tyres.....	139
2.17 Repairs & Maintenance of Electrical Equipment.....	140
2.18 Repairs of Components of Motor Vehicles.....	141 - 144
2.19 Repairs of Computers and Services on Hardware.....	145 - 147
2.20 Repairs of Construction Machinery & Equipment.....	148 - 148
2.21 Repairs of Office Furniture (Wooden & Steel).....	149
2.22 Repairs to Laboratory and Weighing Equipment, Dial Gauges.....	150
2.23 Security Service.....	151
2.24 Software Development / Consultancy and Related Services.....	152
2.25 Surveying and Providing the Related Services.....	153 - 155
2.26 Tailoring Uniforms and Curtain Material.....	156 - 156
2.27 Tinkering, Painting and Welding Repair Works for Vehicles and Machinery.....	157 - 160
2.28 Upholstery Works Including Seat Covers.....	161 - 163
2.29 Wharf Clearing, Transport and Delivery of Imported Goods.....	Not Reg
2.30 Pest Control.....	165
2.31 Translation (in Sinhala, Tamil and English).....	Not Reg
2.32 Under Water Investigation and Related Services.....	Not Reg
2.33 Document Scanning Services (Types A0- Type A4).....	168

1.1 Binding Machines

1 New General Trading

Specilized Products / Brands

Business
Reg. No

CPC/KY/
DS/2/2/48
38



No.06, Kumara Veediya, Kandy

-	-	-
-	-	-



0812222050



0814481357



newgeneral1786@yahoo.com

RDA Reg No.

RDASR

0296

2

Vanoj Office Automation

Specilized Products / Brands

Business
Reg. No

1767



561/40,Preeman Mw, Anuradhapura

Photo copier	Fax machin	Laptop
Computers	Toner, Cartridge	



0254580054



0252226900



vanojoffice@gmail.com

RDA Reg No.

RDASR

1014

3

Koneshwaran Engineering Contractor

Specilized Products / Brands

Business
Reg. No

313



186/12, Kurumankadu, Vavuniya

-	-	-
-	-	-



0778806684



-



-

RDA Reg No.

























RDASR

1021

1.2 CCTV Cameras

1	VS Information Systems (Pvt) Ltd	Specilized Products / Brands	Business Reg. No	PV66809						
	No.07, suleiman Terrace, Colombo 05	<table border="1"> <tr><td>-</td><td>-</td><td>-</td></tr> <tr><td>-</td><td>-</td><td>-</td></tr> </table>	-	-	-	-	-	-		
-	-	-								
-	-	-								
	0112038500									
	0112555805									
	marketingsupport@vsis.lk/sales@vsis.lk		RDA Reg No.	RDASR 0067						
2	Call Lanka Telecom (Pvt) Ltd	Specilized Products / Brands	Business Reg. No	PV13180						
	No.10/6, Dewananda Rd, Nawinna, Maharagama	<table border="1"> <tr><td>Dahua</td><td>NEC</td><td>Hikvision</td></tr> <tr><td>CP Plus</td><td>-</td><td></td></tr> </table>	Dahua	NEC	Hikvision	CP Plus	-			
Dahua	NEC	Hikvision								
CP Plus	-									
	0112810540									
	0112803805									
	calllanka@shnet.lk		RDA Reg No.	RDASR 0116						
3	Browns Engineering and Construction (Pvt) Ltd	Specilized Products / Brands	Business Reg. No	PV129313						
	No.481, T.B.Jayah Mw, Colombo 10	<table border="1"> <tr><td>-</td><td>-</td><td>-</td></tr> <tr><td>-</td><td>-</td><td>-</td></tr> </table>	-	-	-	-	-	-		
-	-	-								
-	-	-								
	0117644525									
	0117644548									
	bec@brownsinvestments.com		RDA Reg No.	RDASR 0142						
4	Micro Channel Lanka (Pvt) Ltd	Specilized Products / Brands	Business Reg. No	DS/MN/C/BR/764						
	No.165D, New Kalmunai, Batticaloa	<table border="1"> <tr><td>-</td><td>-</td><td>-</td></tr> <tr><td>-</td><td>-</td><td>-</td></tr> </table>	-	-	-	-	-	-		
-	-	-								
-	-	-								
	0762339997/0773201786/0777710086/0765788774									
	0652224646									
	info@mclpvt.lk		RDA Reg No.	RDASR 0261						
5	Netsys Solutions (Pvt) Ltd	Specilized Products / Brands	Business Reg. No	PV86501						
	No.44A, Liyanage Mw, Vijithapura, Pelawatta, Battaramulla	<table border="1"> <tr><td>Cisco</td><td>Hewlett Packard</td><td>Fortinet</td></tr> <tr><td>Ruckus</td><td>Dell EMC</td><td></td></tr> </table>	Cisco	Hewlett Packard	Fortinet	Ruckus	Dell EMC			
Cisco	Hewlett Packard	Fortinet								
Ruckus	Dell EMC									
	0117376321/0112787300/0117699300									
	0112787500									
	info@netsys.lk		RDA Reg No.	RDASR 0281						
6	Lakmuthu IT Solutions	Specilized Products / Brands	Business Reg. No	27/3834						
	St. Mary's rd, Chilaw	<table border="1"> <tr><td>Hikvision</td><td>-</td><td>-</td></tr> <tr><td>-</td><td>-</td><td>-</td></tr> </table>	Hikvision	-	-	-	-	-		
Hikvision	-	-								
-	-	-								
	0322221210									
	-									
	office@lakmuthu.com		RDA Reg No.	RDASR 0403						

1.2 CCTV Cameras

7	Sashira International	Specilized Products / Brands	Business Reg. No	WJ6281									
	 No.185 T, Rathna Mw, Niwanthidiya, Piliyandala	<table border="1"> <tr> <td>Steel Furniture</td> <td>Fiber Cables</td> <td>Fusion Splicing Machine</td> </tr> <tr> <td>Telecommunication Accessories</td> <td>All Type Connectors</td> <td></td> </tr> </table>	Steel Furniture	Fiber Cables	Fusion Splicing Machine	Telecommunication Accessories	All Type Connectors						
Steel Furniture	Fiber Cables	Fusion Splicing Machine											
Telecommunication Accessories	All Type Connectors												
	 0112819770/1  0112819772  sashira-int@sltnet.lk		RDA Reg No.	RDASR 0456									
8	Advanced Micro Technology (Pvt) ltd	Specilized Products / Brands	Business Reg. No	PV10779									
	 M 01, Lily Avenue, Robert Gunawardana Mw, Battaramulla	<table border="1"> <tr> <td>Roger</td> <td>Automatic System</td> <td>-</td> </tr> <tr> <td>-</td> <td>-</td> <td></td> </tr> </table>	Roger	Automatic System	-	-	-						
Roger	Automatic System	-											
-	-												
	 0112864225  0112883735  amtnet@sltnet.lk/hiran@amtsl.com		RDA Reg No.	RDASR 0515									
9	Nilwala Enterprises	Specilized Products / Brands	Business Reg. No	WK14074									
	 Nilwala, Ihalayagoda, Imbulgoda	<table border="1"> <tr> <td>-</td> <td>-</td> <td>-</td> </tr> <tr> <td>-</td> <td>-</td> <td></td> </tr> </table>	-	-	-	-	-						
-	-	-											
-	-												
	 0714477007  -  nilwalaenterprises.lk@gmail.com		RDA Reg No.	RDASR 0532									
10	K.N.C.Computer Technologies Pvt ltd	Specilized Products / Brands	Business Reg. No	PV76241									
	 No.21 A, Station Rd, Matara	<table border="1"> <tr> <td>-</td> <td>-</td> <td>-</td> </tr> <tr> <td>-</td> <td>-</td> <td></td> </tr> </table>	-	-	-	-	-						
-	-	-											
-	-												
	 04122342222  0412234222  knccomputer@gmail.com		RDA Reg No.	RDASR 0653									
11	Neat Lanka Pvt Ltd	Specilized Products / Brands	Business Reg. No	P.V.3001									
	 No.455/1/A, Galle rd, Colombo 06	<table border="1"> <tr> <td>-</td> <td>-</td> <td>-</td> </tr> <tr> <td>-</td> <td>-</td> <td></td> </tr> </table>	-	-	-	-	-						
-	-	-											
-	-												
	 0115565000/0777326720/0773979783  0112500704  neatlk@slt.lk		RDA Reg No.	RDASR 0693									
12	Metropolitan Technologies (Pvt) Ltd	Specilized Products / Brands	Business Reg. No	Pr9395									
	 No.12, Magazine rd, Colombo 08	<table border="1"> <tr> <td>Omigo-Air Condition</td> <td>Acer-Computer</td> <td>PHILIPINA-Printers</td> </tr> <tr> <td>Engineeri</td> <td>Ringbu</td> <td></td> </tr> <tr> <td></td> <td>RDC</td> <td></td> </tr> </table>	Omigo-Air Condition	Acer-Computer	PHILIPINA-Printers	Engineeri	Ringbu			RDC			
Omigo-Air Condition	Acer-Computer	PHILIPINA-Printers											
Engineeri	Ringbu												
	RDC												
	 0114700200  0114700267  salesmal@metropolitan.lk		RDA Reg No.	RDASR 0866									

1.2 CCTV Cameras

13 Suprim Computers

C.149/1B, Medawatta, Meneriwatta, Parakaduwa

0714831122/0719498123

-

bapfernandoo@gmail.com

Specilized Products / Brands

-	-	-
-	-	-

Business Reg. No

R/Kuru/13
67

RDA Reg No.

RDASR 0756

14 Debug Computer Peripherals (Pvt) Ltd

No.58, 42nd Lane, Wellawatta, Colombo 06

0117520000

0112362612/0112589597

corporate@debugisp.net/sanjeewaw2debugisp.net

Specilized Products / Brands

DCP	EPSON	KTUCCER
BENQ	SOPHOS	A

Business Reg. No

PV2347

RDA Reg No.

RDASR 0769

15 Softlogic Retail (Pvt) Ltd

No.402, Level-3, Panasonoc Building, Galle rd, Colombo 03

0115391100

0112375151

kusal@softlogic.lk

Specilized Products / Brands

-	-	-
-	-	-

Business Reg. No

PV5912

RDA Reg No.

RDASR 0946

16 NSL Distribution (Pvt) ltd

No.202/2, 1st Lane, Egodawatta, Boralesgamuwa

0117212129/0713050571

0711004511

info@nsl.lk

Specilized Products / Brands

-	-	-
-	-	-

Business Reg. No

PV130174

RDA Reg No.

RDASR 0951

17 Assidua Technologies (Pvt) Ltd

No.149, Galle rd, Dehiwala

0112710088/0112710090

0112710089

tenders@assiduaonline.com/almeida@assiduaonline.com

Specilized Products / Brands

UPS	UPS	Inverters
Stabilizers	Rotation Transformer	

Business Reg. No

PV84838

RDA Reg No.

RDASR 1026

18 Sumathi Information Technologies (Pvt) Ltd

No.491, Galle rd, Colombo 03

0773887013/0115553311

0115553312

info@sit.lk

Specilized Products / Brands

Pix4D	TRD	Karaer Advanced
-	-	

Business Reg. No

PV417

RDA Reg No.

RDASR 1035

1.2 CCTV Cameras

19 Fentons Ltd



180, Deans rd, Colombo 10



0112448518



0112448517



info@hayleysfentons.com

Specilized Products / Brands

NEC	Bosch	Carrier
Gree	-	

Business
Reg. No

PB334

RDA Reg No.

RDASR 1042

1.3 Computer Stationery (Toners, Cartridge, Ink Ribbons, Master Rolls)

1 **Techno Forms (Pvt) Ltd** Specilized Products / Brands Business Reg. No PV5699

-	-	-
-	-	

No.4A, Hunupitiya Cross Rd, Colombo 02

0112564945/6
0112564912
sales@tfm.lk

RDA Reg No. RDASR 0003

2 **L.H.Chandrasekara & Brothers (Pvt) Ltd** Specilized Products / Brands Business Reg. No PV9290

-	-	-
-	-	

No.80, King's Street, Kandy

0812234270/0812228527/0814479437
0814470398
info@chandrasekaragroup.com

RDA Reg No. RDASR 0025

3 **S M A Technologies** Specilized Products / Brands Business Reg. No W/T/I 8044

-	-	-
-	-	

376/16, Kerawalapitiya Rd, Hendala, Wattala

0115238299
0115238377
info@smatechnologies.net

RDA Reg No. RDASR 0034

4 **Tillmax Pvt Ltd** Specilized Products / Brands Business Reg. No PV7042

-	-	-
-	-	

No.140/1, Kethsiri Sevana, Thumbowila, Piliyandala

0117355355
.117355350
info@tillmax.lk

RDA Reg No. RDASR 0039

5 **Shine Tech Solutions** Specilized Products / Brands Business Reg. No W26672

-	-	-
-	-	

No.375, Bathalohenawatta, Gonawala, Kelaniya

0112715769/0712923105
0115715769
shinetechsolutions@hotmail.com

RDA Reg No. RDASR 0045

6 **Suncom Networks (Pvt) Ltd** Specilized Products / Brands Business Reg. No PV62129

-	-	-
-	-	

28, Dampitiyawa Rd, Padukka

0112184760
-
suncom@sltnet.lk

RDA Reg No. RDASR 0063

1.3 Computer Stationery (Toners, Cartridge, Ink Ribbons, Master Rolls)

7 **VS Information Systems (Pvt) Ltd** Specilized Products / Brands Business Reg. No PV66809

-	-	-
-	-	

No.07, suleiman Terrace, Colombo 05

0112038500
0112555805
marketingsupport@vsis.lk/sales@vsis.lk

RDA Reg No. RDASR 0067

8 **Kyron Technology** Specilized Products / Brands Business Reg. No WS11906

HP	EPSON	Samsung
Brother	Lexmark	

176, Dippitiyagoda rd, Dalugama, Kelaniya

0766634442
0112914646
kyrontechnology1@gmail.com

RDA Reg No. RDASR 0069

9 **S.B.Printers (Pvt) Ltd** Specilized Products / Brands Business Reg. No PV6485

-	-	-
-	-	

No.441/3, 03rd Kurana, Colombo Rd, Negombo

0312222069
0312228926
sbprinters@sltnet.lk

RDA Reg No. RDASR 0075

10 **Oringo Stationary** Specilized Products / Brands Business Reg. No C21026

-	-	-
-	-	

23/77, Pragathipura, Madiwela, Kotte

0112779506/0723928749
-
kvindumanjulla13@gmail.com

RDA Reg No. RDASR 0195

11 **Sunshine Stationers** Specilized Products / Brands Business Reg. No WA89612

-	-	-
-	-	

No.112, Bright Plaza, Maliban Street, Colombo 11

0112380389/0777875105
0112380389
info.sunshine stationers

RDA Reg No. RDASR 0206

12 **Metro Stationery** Specilized Products / Brands Business Reg. No W/A 109032

























-	-	-
-	-	

40, 1st Floor Maliban Street, Colombo 11

























0112445347/0773867192
011445347
info.metro@gmail.com

RDA Reg No. RDASR 0213

1.3 Computer Stationery (Toners, Cartridge, Ink Ribbons, Master Rolls)

13	D2 Technologies (pvt) Ltd	Specilized Products / Brands	Business Reg. No	PV61237									
	 No.182/2A, Galle Rd, Mount Lavinia	<table border="1"> <tr> <td>Computer</td> <td>Toners</td> <td>-</td> </tr> <tr> <td>-</td> <td>-</td> <td></td> </tr> </table>	Computer	Toners	-	-	-						
Computer	Toners	-											
-	-												
	 0112710560												
	 0112761395												
	 christo@d2lanka.com		RDA Reg No.	RDASR 0240									
14	Pilot Stationers (Pvt) Ltd	Specilized Products / Brands	Business Reg. No	PV10142									
	 No.132, Dam Street, Colombo 12	<table border="1"> <tr> <td>Avaion</td> <td>Conguero</td> <td>Box Files</td> </tr> <tr> <td>Chatang</td> <td>r Beard/</td> <td></td> </tr> <tr> <td>Denere</td> <td>-</td> <td></td> </tr> </table>	Avaion	Conguero	Box Files	Chatang	r Beard/		Denere	-			
Avaion	Conguero	Box Files											
Chatang	r Beard/												
Denere	-												
	 0112344445/0112433311												
	 0112430718/717												
	 pilot@slt.net.lk/pilot-purchase@slt.net.lk		RDA Reg No.	RDASR 0250									
15	Micro Channel Lanka (Pvt) Ltd	Specilized Products / Brands	Business Reg. No	DS/MN/C/B R/764									
	 No.165D, New Kalmunai, Batticaloa	<table border="1"> <tr> <td>-</td> <td>-</td> <td>-</td> </tr> <tr> <td>-</td> <td>-</td> <td></td> </tr> </table>	-	-	-	-	-						
-	-	-											
-	-												
	 0762339997/0773201786/0777710086/076												
	 0652224646												
	 info@mcipvt.lk		RDA Reg No.	RDASR 0261									
16	Accell Technology Holding Pvt Ltd	Specilized Products / Brands	Business Reg. No	PV105899									
	 No.17B, Glender Place , Colombo 04	<table border="1"> <tr> <td>-</td> <td>-</td> <td>-</td> </tr> <tr> <td>-</td> <td>-</td> <td></td> </tr> </table>	-	-	-	-	-						
-	-	-											
-	-												
	 0112587511												
	 0112587512												
	 sales@accelltecs.l.com		RDA Reg No.	RDASR 0267									
17	New General Trading	Specilized Products / Brands	Business Reg. No	CPC/KY/D S/2/2/4838									
	 No.06, Kumara Veediya, Kandy	<table border="1"> <tr> <td>-</td> <td>-</td> <td>-</td> </tr> <tr> <td>-</td> <td>-</td> <td></td> </tr> </table>	-	-	-	-	-						
-	-	-											
-	-												
	 0812222050												
	 0814481357												
	 newgeneral1786@yahoo.com		RDA Reg No.	RDASR 0296									
18	Genesis IT	Specilized Products / Brands	Business Reg. No	W/RT/5667									
	 No.40, Balapokuna Rd, Kirulapana, Colombo 06	<table border="1"> <tr> <td>-</td> <td>-</td> <td>-</td> </tr> <tr> <td>-</td> <td>-</td> <td></td> </tr> </table>	-	-	-	-	-						
-	-	-											
-	-												
	 0112815479												
	 0112815479												
	 genesisitk@gmail.com		RDA Reg No.	RDASR 0300									

























1.3 Computer Stationery (Toners, Cartridge, Ink Ribbons, Master Rolls)

19	Gestetner of Ceylon PLC	Specilized Products / Brands	Business Reg. No	PQ215						
	 No.248, Vauxhall Street, Colombo 2	<table border="1"><tr><td>-</td><td>-</td><td>-</td></tr><tr><td>-</td><td>-</td><td>-</td></tr></table>	-	-	-	-	-	-		
-	-	-								
-	-	-								
	 0114725500									
	 0112541357									
	 gocl@gestetnersl.com		RDA Reg No.	RDASR 0304						
20	Reprographics (Pvt) Ltd	Specilized Products / Brands	Business Reg. No	PV11733						
	 No.70, 2nd Floor, Lucky Plaza, St. Anthony's Mw, Colombo 03	<table border="1"><tr><td>Photocopy</td><td>Toners</td><td>-</td></tr><tr><td>-</td><td>-</td><td>-</td></tr></table>	Photocopy	Toners	-	-	-	-		
Photocopy	Toners	-								
-	-	-								
	 0115741975/6									
	 0112372899									
	 rgsales@access.lk/reprosales@access.lk		RDA Reg No.	RDASR 0373						
21	PC Care & Cure (Pvt) Ltd	Specilized Products / Brands	Business Reg. No	PV0020998 9						
	 No.132, King Street, Matale	<table border="1"><tr><td>-</td><td>-</td><td>-</td></tr><tr><td>-</td><td>-</td><td>-</td></tr></table>	-	-	-	-	-	-		
-	-	-								
-	-	-								
	 0662232032/0777385535									
	 0662232032									
	 pccarematale@gmail.com		RDA Reg No.	RDASR 0381						
22	Lakmuthu IT Solutions	Specilized Products / Brands	Business Reg. No	27/3834						
	 St. Mary's rd, Chilaw	<table border="1"><tr><td>Hikvision</td><td>-</td><td>-</td></tr><tr><td>-</td><td>-</td><td>-</td></tr></table>	Hikvision	-	-	-	-	-		
Hikvision	-	-								
-	-	-								
	 0322221210									
	 -									
	 office@lakmuthu.com		RDA Reg No.	RDASR 0403						
23	Imtiaz Packirdeen	Specilized Products / Brands	Business Reg. No	U/Badu/942 0						
	 No.5, Lower Street, Badulla	<table border="1"><tr><td>-</td><td>-</td><td>-</td></tr><tr><td>-</td><td>-</td><td>-</td></tr></table>	-	-	-	-	-	-		
-	-	-								
-	-	-								
	 0552222497									
	 0552223442									
	 imtiazcad@gmail.com		RDA Reg No.	RDASR 0405						
24	GS Technology	Specilized Products / Brands	Business Reg. No	-						
	 No.84/2, Negambo Rd, Seeduwa	<table border="1"><tr><td>Singer</td><td>Softlogic</td><td>Fast</td></tr><tr><td>Debug</td><td>Trendnet</td><td></td></tr></table>	Singer	Softlogic	Fast	Debug	Trendnet			
Singer	Softlogic	Fast								
Debug	Trendnet									
	 0113476060									
	 0112253640									
	 info@gstechnologylk.com/www.gstechnolog		RDA Reg No.	RDASR 0427						

1.3 Computer Stationery (Toners, Cartridge, Ink Ribbons, Master Rolls)

25	John Keells Office Automation (Pvt) Ltd	Specilized Products / Brands	Business Reg. No	PV127407												
	No.90, Union Place, Colombo 02	<table border="1"> <tr> <td>ASUS</td> <td>ASUS</td> <td>TOSHIBA</td> </tr> <tr> <td>Deskton</td> <td>Laptop</td> <td>Photocopy</td> </tr> <tr> <td>Viewsonic</td> <td>Samsung</td> <td></td> </tr> <tr> <td>Multimedia</td> <td></td> <td></td> </tr> </table>	ASUS	ASUS	TOSHIBA	Deskton	Laptop	Photocopy	Viewsonic	Samsung		Multimedia				
ASUS	ASUS	TOSHIBA														
Deskton	Laptop	Photocopy														
Viewsonic	Samsung															
Multimedia																
	0112313000															
	0112431745															
	jkoa@keells.com		RDA Reg No.	RDASR 0429												
26	Galle City Suppliers (Pvt) Ltd	Specilized Products / Brands	Business Reg. No	PV122771												
	No.69, Main Street, Kaduruwela	<table border="1"> <tr> <td>-</td> <td>-</td> <td>-</td> </tr> <tr> <td>-</td> <td>-</td> <td></td> </tr> </table>	-	-	-	-	-									
-	-	-														
-	-															
	0272056205															
	-															
	gallecitystores7@gmail.com		RDA Reg No.	RDASR 0450												
27	M.N.Office Automation	Specilized Products / Brands	Business Reg. No	NCP/TK/1/4/1412												
	No.54, Batticalo rd, Polonnaruwa	<table border="1"> <tr> <td>Photocop y Machine</td> <td>Toners</td> <td>Computer</td> </tr> <tr> <td>Loptops</td> <td>PAINTS</td> <td></td> </tr> </table>	Photocop y Machine	Toners	Computer	Loptops	PAINTS									
Photocop y Machine	Toners	Computer														
Loptops	PAINTS															
	0272226757/077305															
	-															
	mnoffice76@gmail.com		RDA Reg No.	RDASR 0473												
28	Sanikto Computer (Pvt) Ltd	Specilized Products / Brands	Business Reg. No	PV104632												
	No.928/5, Eksath Subasadaka Mw, Udawatta rd, Malabe	<table border="1"> <tr> <td>Toners</td> <td>Ribbons</td> <td>Carridges</td> </tr> <tr> <td>All Types</td> <td>Alltypes</td> <td></td> </tr> <tr> <td>Computer</td> <td>Printers</td> <td></td> </tr> </table>	Toners	Ribbons	Carridges	All Types	Alltypes		Computer	Printers						
Toners	Ribbons	Carridges														
All Types	Alltypes															
Computer	Printers															
	0112080270/0112083917/0779229698/071															
	0112080270/0112053917															
	saniktocomputer@gmail.com/saniktocompu		RDA Reg No.	RDASR 0488												
29	Inwin Marketing (Pvt) Ltd	Specilized Products / Brands	Business Reg. No	4073975												
	126/9/1/1, Halpita, Polgasowita, 10320	<table border="1"> <tr> <td>Surgical</td> <td>Sanitizer/</td> <td>Disinfectio</td> </tr> <tr> <td>Computer</td> <td>Unels,</td> <td></td> </tr> <tr> <td>Accessori</td> <td>Cartridges</td> <td></td> </tr> </table>	Surgical	Sanitizer/	Disinfectio	Computer	Unels,		Accessori	Cartridges						
Surgical	Sanitizer/	Disinfectio														
Computer	Unels,															
Accessori	Cartridges															
	0112180842															
	0112183142															
	inwinmarketingpvt@gmail.com		RDA Reg No.	RDASR 0502												
30	PC Global Systems (Pvt) Ltd	Specilized Products / Brands	Business Reg. No	PV20072												
	No.25, Alexandra Rd, Colombo 06	<table border="1"> <tr> <td>-</td> <td>-</td> <td>-</td> </tr> <tr> <td>-</td> <td>-</td> <td></td> </tr> </table>	-	-	-	-	-									
-	-	-														
-	-															
	0112599804/0112553631/0112506465															
	0112599803															
	sales@pcglobesystems.lk		RDA Reg No.	RDASR 0529												

1.3 Computer Stationery (Toners, Cartridge, Ink Ribbons, Master Rolls)

31	Nilwala Enterprises	Specilized Products / Brands	Business Reg. No	WK14074						
	 Nilwala, lhalayagoda, Imbulgoda  0714477007  -  nilwalaenterprises.lk@gmail.com	<table border="1"> <tr><td>-</td><td>-</td><td>-</td></tr> <tr><td>-</td><td>-</td><td>-</td></tr> </table>	-	-	-	-	-	-	RDA Reg No.	RDASR 0532
-	-	-								
-	-	-								
32	C.S.Enterprises	Specilized Products / Brands	Business Reg. No	NCP00167 2						
	 No.414/1, Godage Mw, Anuradhapura  0718723000/0254580628  0252227147  csenterprises18@gmail.com	<table border="1"> <tr><td>ID Card Printer</td><td>-</td><td>-</td></tr> <tr><td>-</td><td>-</td><td>-</td></tr> </table>	ID Card Printer	-	-	-	-	-	RDA Reg No.	RDASR 0558
ID Card Printer	-	-								
-	-	-								
33	Taibah Marketing (Pvt) Ltd	Specilized Products / Brands	Business Reg. No	PV66302						
	 No.46/1, Main Street, Nintavur-24  0672250881  0672251219  taibah@sltnet.lk	<table border="1"> <tr><td>Toshiba Toner</td><td>Samsung Toner</td><td>Canon Toner</td></tr> <tr><td>-</td><td>-</td><td>-</td></tr> </table>	Toshiba Toner	Samsung Toner	Canon Toner	-	-	-	RDA Reg No.	RDASR 0563
Toshiba Toner	Samsung Toner	Canon Toner								
-	-	-								
34	Nec Technologies	Specilized Products / Brands	Business Reg. No	RPDS/ADM /RC/01/BR G/0270						
	 No.58, New Town, Rathnapura  0452228162  0452050877  82nectechnologies@gmail.com	<table border="1"> <tr><td>Toner, Photocop Machine</td><td>Ribben Fax Machine</td><td>Computer Printers</td></tr> <tr><td>-</td><td>-</td><td>-</td></tr> </table>	Toner, Photocop Machine	Ribben Fax Machine	Computer Printers	-	-	-	RDA Reg No.	RDASR 0603
Toner, Photocop Machine	Ribben Fax Machine	Computer Printers								
-	-	-								
35	K.N.C.Computer Technologies Pvt ltd	Specilized Products / Brands	Business Reg. No	PV76241						
	 No.21 A, Station Rd, Matara  04122342222  0412234222  knccomputer@gmail.com	<table border="1"> <tr><td>-</td><td>-</td><td>-</td></tr> <tr><td>-</td><td>-</td><td>-</td></tr> </table>	-	-	-	-	-	-	RDA Reg No.	RDASR 0653
-	-	-								
-	-	-								
36	Metropolitan Technologies (Pvt) Ltd	Specilized Products / Brands	Business Reg. No	Pr9395						
	 No.12, Magazine rd, Colombo 08  0114700200  0114700267  salesmal@metropolitan.lk	<table border="1"> <tr><td>Chigo-Air Conditioner</td><td>Acer Computer</td><td>EPSON Printers</td></tr> <tr><td>-</td><td>-</td><td>-</td></tr> </table>	Chigo-Air Conditioner	Acer Computer	EPSON Printers	-	-	-	RDA Reg No.	RDASR 0866
Chigo-Air Conditioner	Acer Computer	EPSON Printers								
-	-	-								

1.3 Computer Stationery (Toners, Cartridge, Ink Ribbons, Master Rolls)

37 **Data Tech Business Centre (Pvt) Ltd** Specilized Products / Brands Business Reg. No PV13378

-	-	-
-	-	-

45A, Dehiwala rd, Pepiliyana

0117631610/11

-

info@datatechlk.com RDA Reg No. RDASR 0730

38 **S/L State Trading (General0 Corporation Ltd** Specilized Products / Brands Business Reg. No PB863

Nano mark	STC Mark	STC Sensitizer
-	-	-

No.100, Nawam Mw, Colombo 02

0112422342/4

0112447970

lankagen@slt.net.lk RDA Reg No. RDASR 0881

39 **Rothing Stationers** Specilized Products / Brands Business Reg. No WA82171

-	-	-
-	-	-

No.9, Mayuri Lane, Colombo 11

0112334009

0112334009

rotringstationers@gmail.com RDA Reg No. RDASR 0895

40 **Max Trading** Specilized Products / Brands Business Reg. No WA209594

Stationery	Toners	-
-	-	-

No.16, Keerthi Lane (JJ), Maliban Street, Colombo 11

01123275460771994865

0112327546

maxtradingmxt26@gmail.com RDA Reg No. RDASR 0896

41 **Speed Technology** Specilized Products / Brands Business Reg. No WA/212015

Toners	Stationery	-
-	-	-

No.112, 1/1, Bright Plaza, Maliban Street, Colombo 11

0776060390

0112323867

speedtechnologysto@gmail.com RDA Reg No. RDASR 0897

42 **Asiri Stationery** Specilized Products / Brands Business Reg. No WA204472

Office Stationery	Toners	-
-	-	-

No.112,1/12, Bright Plaza, Maliban Street, Colombo 11

0112323867/0773019230

0112323867

asiristationeryas7@gmail.com RDA Reg No. RDASR 0903

1.3 Computer Stationery (Toners, Cartridge, Ink Ribbons, Master Rolls)

43 **A. One Print Solution** Specilized Products / Brands Business Reg. No W/203096

-	-	-
-	-	-

No.100, Crystal Market, 1/1, Keyzer Street, Colombo 11

0112449284/0767660061

0112449284

aoneprintsolution16@gmail.com RDA Reg No. RDASR 0904

44 **Modern Computer Systems** Specilized Products / Brands Business Reg. No W/T/1/5891

HP	Canon	Epson
-	-	-

No.62/16, Hettiya Watta, Elapitiwala, Ragama

0112967093

-

moderncoms@gmail.com RDA Reg No. RDASR 0908

45 **Indigo Asia Computer Systems** Specilized Products / Brands Business Reg. No WJ5208

HP	-	-
-	-	-

21/5A, Polhengoda Gardens, Colombo 05

0115018786/0777514227

0112825466

indigoasia@sltnet.lk RDA Reg No. RDASR 0912

46 **ABC Trade & Investments (Pvt) Ltd** Specilized Products / Brands Business Reg. No PV12558

Promate	Kodak	Print-rite
VIISAN	Rongta	

No.03, Bandaranayakapura rd, Rajagiriya

0115877700

0112868555

tenders@abcsrilanka.biz RDA Reg No. RDASR 0752

47 **Ewis Peripherals (Pvt) Ltd** Specilized Products / Brands Business Reg. No PV10130

Lexmark	Konica	pantum
Octa	minolta	
matrix	Riello	

No.142, Yathama Building, Galle rd, Colombo 03

0117496000

0112380580

peripherals@ewisl.net/dineshw@ewisl.net RDA Reg No. RDASR 0762

48 **K.T. Office Automation (Pvt) Ltd** Specilized Products / Brands Business Reg. No PV21518

-	-	-
-	-	-

























Head Office:-no.310E, Negombo rd, Kurunegala /Branch:- 1/77-G, Akkara 10, Bangalawatta, Kottawa

0113418969/0372223666

0372230893

info@ktoa.lk RDA Reg No. RDASR 0763

1.3 Computer Stationery (Toners, Cartridge, Ink Ribbons, Master Rolls)

49	Debug Computer Peripherals (Pvt) Ltd	Specilized Products / Brands	Business Reg. No	PV2347						
	 No.58, 42nd Lane, Wellawatta, Colombo 06	<table border="1"> <tr> <td>DCP</td> <td>EPSON</td> <td>KTUOLER</td> </tr> <tr> <td>BENQ</td> <td>SOPHOS</td> <td></td> </tr> </table>	DCP	EPSON	KTUOLER	BENQ	SOPHOS			
DCP	EPSON	KTUOLER								
BENQ	SOPHOS									
	 0117520000									
	 0112362612/0112589597									
	 corporate@debugisp.net/sanjeewaw2debug		RDA Reg No.	RDASR 0769						
50	Anudi Products	Specilized Products / Brands	Business Reg. No	3/11/355						
	 Wewudaththa, Nakulugamuwa	<table border="1"> <tr> <td>-</td> <td>-</td> <td>-</td> </tr> <tr> <td>-</td> <td>-</td> <td></td> </tr> </table>	-	-	-	-	-			
-	-	-								
-	-									
	 0711360696									
	 -									
	 priyasuad2012@gmail.com		RDA Reg No.	RDASR 0916						
51	Narah Computer Foems	Specilized Products / Brands	Business Reg. No	WA31987						
	 309/4C, Negombo rd, Welisara	<table border="1"> <tr> <td>-</td> <td>-</td> <td>-</td> </tr> <tr> <td>-</td> <td>-</td> <td></td> </tr> </table>	-	-	-	-	-			
-	-	-								
-	-									
	 0112245700-888									
	 0112245900/0112230061									
	 narahncf@gmail.com		RDA Reg No.	RDASR 0950						
52	NSL Distribution (Pvt) Ltd	Specilized Products / Brands	Business Reg. No	PV130174						
	 No.202/2, 1st Lane, Egodawatta, Boralessgamuwa	<table border="1"> <tr> <td>-</td> <td>-</td> <td>-</td> </tr> <tr> <td>-</td> <td>-</td> <td></td> </tr> </table>	-	-	-	-	-			
-	-	-								
-	-									
	 0117212129/0713050571									
	 0711004511									
	 info@nsl.lk		RDA Reg No.	RDASR 0951						
53	Business Machines Co. (Pvt) Ltd	Specilized Products / Brands	Business Reg. No	PV8363						
	 No.1,Lake Crescent, Colombo 02	<table border="1"> <tr> <td>-</td> <td>-</td> <td>-</td> </tr> <tr> <td>-</td> <td>-</td> <td></td> </tr> </table>	-	-	-	-	-			
-	-	-								
-	-									
	 0112304380									
	 0112304381									
	 info@biz-machines.com		RDA Reg No.	RDASR 0972						
54	Cybersoft	Specilized Products / Brands	Business Reg. No	CP/MT/Div/ 3/4/7/748						
	 Computer Systems	<table border="1"> <tr> <td>-</td> <td>-</td> <td>-</td> </tr> <tr> <td>-</td> <td>-</td> <td></td> </tr> </table>	-	-	-	-	-			
-	-	-								
-	-									
	 0662226126									
	 0662226126									
	 csoft82@gmail.com		RDA Reg No.	RDASR 0987						

1.3 Computer Stationery (Toners, Cartridge, Ink Ribbons, Master Rolls)

55 **Simplex Corporation (Pvt) Ltd** Specilized Products / Brands Business Reg. No PV122895

Toner	Ribben	Cartridge
UPS	Computer	

902D, 7th Floor, Unity Plaza, Bumbalapitiya

0112599792/0115991090
0112599792
tenderdept@simplexcorporation.com

RDA Reg No. RDASR 0989

56 **Fintek Managed Solutions (Pvt) Ltd** Specilized Products / Brands Business Reg. No PV128024

SHARP	Mis	Vivitek
Posmart	Pantum	

No.248, Vauxhall Street, Colombo 02

0117887000
0112431172
damith@finteksl.com

RDA Reg No. RDASR 0990

57 **Vanoj Office Automation** Specilized Products / Brands Business Reg. No 1767

Photo Computer	Tax Invoice, Cartridge	Laptop
----------------	------------------------	--------

561/40, Preeman Mw, Anuradhapura

0254580054
0252226900
vanojoffice@gmail.com

RDA Reg No. RDASR 1014

58 **K.E.Office Automation (Pvt) Ltd** Specilized Products / Brands Business Reg. No PV14116

Toshiba Toner	Kaspesky	Hp
Samsung	Kyocera	

No.369/1/1, Anagarika Dharmapala Mw, Noope, Matara

0714227427
0412234438
keofficemataraho@gmail.com

RDA Reg No. RDASR 1009

59 **Computer Land** Specilized Products / Brands Business Reg. No WP12982

























-	-	-
-	-	

No.86/3, Kurunda Watta rd, Pitakotte

























0777636708
-
computerland321@gmail.com

RDA Reg No. RDASR 01058

























1.4 Computers & Peripheral Equipment

1	Tillmax Pvt Ltd	Specilized Products / Brands	Business Reg. No	PV7042						
	 No.140/1, Kethsiri Sevana, Thumbowila, Piliyandala	<table border="1"><tr><td>-</td><td>-</td><td>-</td></tr><tr><td>-</td><td>-</td><td></td></tr></table>	-	-	-	-	-			
-	-	-								
-	-									
	 0117355355									
	 .117355350									
	 info@tillmax.lk		RDA Reg No.	RDASR 0039						
2	Base HP (Pvt) Ltd	Specilized Products / Brands	Business Reg. No	PV62948						
	 36A, Gower street, Colombo 05	<table border="1"><tr><td>-</td><td>-</td><td>-</td></tr><tr><td>-</td><td>-</td><td></td></tr></table>	-	-	-	-	-			
-	-	-								
-	-									
	 0115746800									
	 0112506633									
	 info@base@hp.lk/gayans@basehp.lk		RDA Reg No.	RDASR 0041						
3	Shine Tech Solutions	Specilized Products / Brands	Business Reg. No	W26672						
	 No.375, Bathalohenawatta, Gonawala, Kelaniya	<table border="1"><tr><td>-</td><td>-</td><td>-</td></tr><tr><td>-</td><td>-</td><td></td></tr></table>	-	-	-	-	-			
-	-	-								
-	-									
	 0112715769/0712923105									
	 0115715769									
	 shinetechsolutions@hotmail.com		RDA Reg No.	RDASR 0045						
4	VS Information Systems (Pvt) Ltd	Specilized Products / Brands	Business Reg. No	PV66809						
	 No.07, suleiman Terrace, Colombo 05	<table border="1"><tr><td>-</td><td>-</td><td>-</td></tr><tr><td>-</td><td>-</td><td></td></tr></table>	-	-	-	-	-			
-	-	-								
-	-									
	 0112038500									
	 0112555805									
	 marketingsupport@vsis.lk/sales@vsis.lk		RDA Reg No.	RDASR 0067						
5	ASTP Tec Pvt Ltd	Specilized Products / Brands	Business Reg. No	PV75727						
	 No.49, 1st Cross Street, Jaffna	<table border="1"><tr><td>Dell</td><td>HP</td><td>-</td></tr><tr><td>-</td><td>-</td><td></td></tr></table>	Dell	HP	-	-	-			
Dell	HP	-								
-	-									
	 0212222674									
	 0212228147									
	 stplingam@gmail.com		RDA Reg No.	RDASR 0151						
6	Trillennium (Pvt) Ltd	Specilized Products / Brands	Business Reg. No	PV108941						
	 1st floor, YMBA Building, Colombo 8	<table border="1"><tr><td>-</td><td>-</td><td>-</td></tr><tr><td>-</td><td>-</td><td></td></tr></table>	-	-	-	-	-			
-	-	-								
-	-									
	 0115315315									
	 0115315316									
	 info@trillennium.biz		RDA Reg No.	RDASR 0224						

1.4 Computers & Peripheral Equipment

7	D2 Technologies (pvt) Ltd	Specilized Products / Brands	Business Reg. No	PV61237						
	No.182/2A, Galle Rd, Mount Lavinia	<table border="1"> <tr> <td>Computer s</td> <td>Toners</td> <td>-</td> </tr> <tr> <td>-</td> <td>-</td> <td></td> </tr> </table>	Computer s	Toners	-	-	-			
Computer s	Toners	-								
-	-									
	0112710560									
	0112761395									
	christo@d2lanka.com		RDA Reg No.	RDASR 0240						
8	Micro Channel Lanka (Pvt) Ltd	Specilized Products / Brands	Business Reg. No	DS/MN/C/B R/764						
	No.165D, New Kalmunai, Batticaloa	<table border="1"> <tr> <td>-</td> <td>-</td> <td>-</td> </tr> <tr> <td>-</td> <td>-</td> <td></td> </tr> </table>	-	-	-	-	-			
-	-	-								
-	-									
	0762339997/0773201786/0777710086/076									
	0652224646									
	info@mclpvt.lk		RDA Reg No.	RDASR 0261						
9	Accell Technology Holding Pvt Ltd	Specilized Products / Brands	Business Reg. No	PV105899						
	No.17B, Glender Place , Colombo 04	<table border="1"> <tr> <td>-</td> <td>-</td> <td>-</td> </tr> <tr> <td>-</td> <td>-</td> <td></td> </tr> </table>	-	-	-	-	-			
-	-	-								
-	-									
	0112587511									
	0112587512									
	sales@accelltecs.l.com		RDA Reg No.	RDASR 0267						
10	Netsys Solutions (Pvt) Ltd	Specilized Products / Brands	Business Reg. No	PV86501						
	No.44A, Liyanage Mw, Vijithapura, Pelawatta, Battaramulla	<table border="1"> <tr> <td>Cisco</td> <td>Hewlett Packard Enterprise</td> <td>Fortinet</td> </tr> <tr> <td>Ruckus</td> <td>Dell EMC</td> <td></td> </tr> </table>	Cisco	Hewlett Packard Enterprise	Fortinet	Ruckus	Dell EMC			
Cisco	Hewlett Packard Enterprise	Fortinet								
Ruckus	Dell EMC									
	0117376321/0112787300/0117699300									
	0112787500									
	info@netsys.lk		RDA Reg No.	RDASR 0281						
11	ABN Traders	Specilized Products / Brands	Business Reg. No	W90661						
	121, Quarry Rd, Dehiwala	<table border="1"> <tr> <td>-</td> <td>-</td> <td>-</td> </tr> <tr> <td>-</td> <td>-</td> <td></td> </tr> </table>	-	-	-	-	-			
-	-	-								
-	-									
	0712294679									
	0112724763									
	abntrader@yahoo.com		RDA Reg No.	RDASR 0310						
12	Lakmuthu IT Solutions	Specilized Products / Brands	Business Reg. No	27/3834						
	St. Mary's rd, Chilaw	<table border="1"> <tr> <td>Hikvision</td> <td>-</td> <td>-</td> </tr> <tr> <td>-</td> <td>-</td> <td></td> </tr> </table>	Hikvision	-	-	-	-			
Hikvision	-	-								
-	-									
	0322221210									
	-									
	office@lakmuthu.com		RDA Reg No.	RDASR 0403						

1.4 Computers & Peripheral Equipment

13	Imtiaz Packirdeen	Specilized Products / Brands	Business Reg. No	U/Badu/94 20						
	 No.5, Lower Street, Badulla	<table border="1"><tr><td>-</td><td>-</td><td>-</td></tr><tr><td>-</td><td>-</td><td></td></tr></table>	-	-	-	-	-			
-	-	-								
-	-									
	 0552222497									
	 0552223442									
	 imtiazcad@gmail.com		RDA Reg No.	RDASR 0405						
14	John Keells Office Automation (Pvt) Ltd	Specilized Products / Brands	Business Reg. No	PV127407						
	 No.90, Union Place, Colombo 02	<table border="1"><tr><td>ASUS Desktop</td><td>ASUS Laptop</td><td>Toshiba Photocopi er</td></tr><tr><td>viewsonic Multimedi a</td><td>Samsung</td><td></td></tr></table>	ASUS Desktop	ASUS Laptop	Toshiba Photocopi er	viewsonic Multimedi a	Samsung			
ASUS Desktop	ASUS Laptop	Toshiba Photocopi er								
viewsonic Multimedi a	Samsung									
	 0112313000									
	 0112431745									
	 jkoa@keells.com		RDA Reg No.	RDASR 0429						
15	Galle City Suppliers (Pvt) Ltd	Specilized Products / Brands	Business Reg. No	PV122771						
	 No.69, Main Street, Kaduruwela	<table border="1"><tr><td>-</td><td>-</td><td>-</td></tr><tr><td>-</td><td>-</td><td></td></tr></table>	-	-	-	-	-			
-	-	-								
-	-									
	 0272056205									
	 -									
	 gallecitystores7@gmail.com		RDA Reg No.	RDASR 0450						
16	#N/A	Specilized Products / Brands	Business Reg. No	#N/A						
	 #N/A	<table border="1"><tr><td>#N/A</td><td>#N/A</td><td>#N/A</td></tr><tr><td>#N/A</td><td>#N/A</td><td></td></tr></table>	#N/A	#N/A	#N/A	#N/A	#N/A			
#N/A	#N/A	#N/A								
#N/A	#N/A									
	 #N/A									
	 #N/A									
	 #N/A		RDA Reg No.	RDASR -						
17	Ceylon Business Appliances (Pvt) Ltd	Specilized Products / Brands	Business Reg. No	PV791						
	 No.112, Reid Avenue, Colombo 04	<table border="1"><tr><td>Densimet ers</td><td>-</td><td>-</td></tr><tr><td>-</td><td>-</td><td></td></tr></table>	Densimet ers	-	-	-	-			
Densimet ers	-	-								
-	-									
	 0117845300									
	 0112503121									
	 sales@cba.lk		RDA Reg No.	RDASR 0451						
18	ABC Computers (Pvt) Ltd	Specilized Products / Brands	Business Reg. No	PV5718						
	 410/11, Bauidddhaloka Mw, Colombo 07	<table border="1"><tr><td>Wacom Tabs</td><td>HP</td><td>Dell</td></tr><tr><td>-</td><td>-</td><td></td></tr></table>	Wacom Tabs	HP	Dell	-	-			
Wacom Tabs	HP	Dell								
-	-									
	 0114710033/0777585730									
	 0112684687									
	 niroshi@abc.lk/sales@abc.lk		RDA Reg No.	RDASR 0465						

1.4 Computers & Peripheral Equipment

19 **st.Antony's Computer** Specilized Products / Brands Business Reg. No J/DS/BR/1 319/2011

 No.189, K.K.S.rd, Jaffna Town, Jaffna

 0212224865

 0212216892

 anthonycomputer@gmail.com

HP	Dell	Canon
Kingston	TPLink	

RDA Reg No. **RDASR 0474**

20 **Sanikto Computer (Pvt) Ltd** Specilized Products / Brands Business Reg. No PV104632

 No.928/5, Eksath Subasadaka Mw, Udawatta rd, Malabe

 0112080270/0112083917/0779229698/071

 0112080270/0112053917

 saniktocomputer@gmail.com/saniktocompu

Toners	Ribbons	Carridges
All types Computer	Alltypes Printers	

RDA Reg No. **RDASR 0488**

21 **C.S.Enterprises** Specilized Products / Brands Business Reg. No NCP00167 2

 No.414/1, Godage Mw, Anuradhapura

 0718723000/0254580628

 0252227147

 csenderprises18@gmail.com

ID Card Printer	-	-
-	-	

RDA Reg No. **RDASR 0558**

22 **Taibah Marketing (Pvt) Ltd** Specilized Products / Brands Business Reg. No PV66302

 No.46/1, Main Street, Nintavur-24

 0672250881

 0672251219

 taibah@sltnet.lk

Toshiba Toners	samsung Toners	Canon Toners
Printer Copy Papers	Tishiba Copiers	

RDA Reg No. **RDASR 0563**

23 **K.N.C.Computer Technologies Pvt ltd** Specilized Products / Brands Business Reg. No PV76241

 No.21 A, Station Rd, Matara

 04122342222

 0412234222

 kncccomputer@gmail.com

-	-	-
-	-	

RDA Reg No. **RDASR 0653**

24 **GIS Solutions (Pvt) Ltd** Specilized Products / Brands Business Reg. No PV85242

 No.370, Galle rd, Colombo 03

 0112575297-9

 0112575297

 info@gislk.com

-	-	-
-	-	

RDA Reg No. **RDASR 0668**

1.4 Computers & Peripheral Equipment

25 **Neat Lanka Pvt Ltd** Specilized Products / Brands Business Reg. No P.V.3001

No.455/1/A, Galle rd, Colombo 06

0115565000/0777326720/0773979783

0112500704

neatlk@slt.lk

-	-	-
-	-	

RDA Reg No. RDASR **0693**

26 **Gennext (Pvt) Ltd** Specilized Products / Brands Business Reg. No PV85489

No.117, Inner Flower rd, Colombo 03

0117801700

-

tenders@gennextteam.lk/thanuja.r2gennext

Dell	-	-
-	-	

RDA Reg No. RDASR **0694**

27 **Abans PLC** Specilized Products / Brands Business Reg. No PV5301PB/PQ

No.498, Galle rd, Colombo 03

0112776978/01157750910/0112565292

0115936364/0114512440/0114512506

janaranga@abansgroup.com/projects@aba

All Conditioners	Refrigerators	Fans
Kettles	Equipments	

RDA Reg No. RDASR **0853**

28 **Metropolitan Technologies (Pvt) Ltd** Specilized Products / Brands Business Reg. No Pr9395

No.12, Magazine rd, Colombo 08

0114700200

0114700267

salesmal@metropolitan.lk

Chigo-Air Conditioners	ACER-Computer	Printronic-Printers
Power Engineering	Nirigo RDC-Duplicators	

RDA Reg No. RDASR **0866**

29 **Data Tech Business Centre (Pvt) Ltd** Specilized Products / Brands Business Reg. No PV13378

45A, Dehiwala rd, Pepiliyana

0117631610/11

-

info@datatechlk.com

-	-	-
-	-	

RDA Reg No. RDASR **0730**

30 **Modern Computer Systems** Specilized Products / Brands Business Reg. No W/T/1/5891

No.62/16, Hettiya Watta, Elapitiwala, Ragama

0112967093

-

moderncoms@gmail.com

HP	Canon	Epson
-	-	

RDA Reg No. RDASR **0908**

1.4 Computers & Peripheral Equipment

31 N Technology Specilized Products / Brands Business Reg. No WC10665

No. 86/3, Kurunduwatta rd, Pitakotte, Kotte

0772966141

0113601170

info@ntechnology.lk

-	-	-
-	-	

RDA Reg No. RDASR **0910**

32 SNV Engineering & Constructions (Pvt) Ltd Specilized Products / Brands Business Reg. No PV0020333 6

No.28, Old Kesbewa rd, Delkanda, Nugegoda

0777661524

-

snvcommunicationsystems@gmail.com

-	-	-
-	-	

RDA Reg No. RDASR **0914**

33 ABC Trade & Investments (Pvt) Ltd Specilized Products / Brands Business Reg. No PV12558

No.03, Bandaranayakapura rd, Rajagiriya

0115877700

0112868555

tenders@abcsrilanka.biz

Promate	Kodak	Print-rite
VIISAN	Rongta	

RDA Reg No. RDASR **0752**

34 Suprim Computers Specilized Products / Brands Business Reg. No R/Kuru/136 7

C.149/1B, Medawatta,Meneriwatta, Parakaduwa

0714831122/0719498123

-

bapfernandoo@gmail.com

-	-	-
-	-	

RDA Reg No. RDASR **0756**

35 Ewis Peripherals (Pvt) Ltd Specilized Products / Brands Business Reg. No PV10130

No.142, Yathama Building, Galle rd, Colombo 03

0117496000

0112380580

peripherals@ewisl.net/dineshw@ewisl.net

Lexmark	Konica minolta	pantum
Octa matrix	Riello	

RDA Reg No. RDASR **0762**

36 K.T. Office Automation (Pvt) Ltd Specilized Products / Brands Business Reg. No PV21518

Head Office:-no.310E, Negombo rd, Kurunegala /Branch:- 1/77-G, Akkara 10, Bangalawatta, Kottawa

0113418969/0372223666

0372230893

info@ktoa.lk

-	-	-
-	-	

RDA Reg No. RDASR **0763**

1.4 Computers & Peripheral Equipment

37 **State Trading (General) Corporation** Specilized Products / Brands Business Reg. No PB863

 No.449, Wlliom Gopallawa Mw, Kandy

 0812200030/50,0702590312

 0812200066

 stckandy@slt.lk/channastc@gmail.com

-	-	-
-	-	

RDA Reg. No. RDASR **0767**

38 **Debug Computer Peripherals (Pvt) Ltd** Specilized Products / Brands Business Reg. No PV2347

 No.58, 42nd Lane, Wellawatta, Colombo 06

 0117520000

 0112362612/0112589597

 corporate@debugisp.net/sanjeewaw2debug

DCP	EPSON	KYOCER A
BENQ	SOPHOS	

RDA Reg. No. RDASR **0769**

39 **ICE Technologies (Pvt) Ltd** Specilized Products / Brands Business Reg. No PV77757

 Sales Office, No.03, 1st Floor, Bandaranayakapura rd, Rajagiriya

 0115231257/0115160260

 0112886757

 tenders@icetechnologies.lk

-	-	-
-	-	

RDA Reg. No. RDASR **0943**

40 **NSL Distribution (Pvt) ltd** Specilized Products / Brands Business Reg. No PV130174

 No.202/2, 1st Lane, Egodawatta, Boralesgamuwa

 0117212129/0713050571

 0711004511

 info@nsl.lk

-	-	-
-	-	

RDA Reg. No. RDASR **0951**

41 **E W Information Systems Ltd** Specilized Products / Brands Business Reg. No PB719

 No.70, 1st floor, Lucky Plaza Building, St. Anthony's Mw, Colombo 03

 0117520520

 0112447303

 info@ewisl.net

Ewis	-	-
-	-	

RDA Reg. No. RDASR **0953**

42 **Cybersoft** Specilized Products / Brands Business Reg. No CP/MT/Div/3/4/7/748

 Computer Systems

 0662226126

 0662226126

 csoft82@gmail.com

-	-	-
-	-	

RDA Reg. No. RDASR **0987**

1.4 Computers & Peripheral Equipment

43 **Vanoj Office Automation** Specilized Products / Brands Business Reg. No 1767

561/40,Preeman Mw, Anuradhapura

0254580054

0252226900

vanojoffice@gmail.com

Photo copier	Fax machin	Laptop
Computer s	Toner, Cartridge	

RDA Reg No. RDASR **1014**

44 **Assidua Technologies (Pvt) Ltd** Specilized Products / Brands Business Reg. No PV84838

No.149, Galle rd, Dehiwala

0112710088/0112710090

0112710089

tenders@assiduaonline.com/almeida@assi

UPS	UPS Batteries	Inverters
Stabilizers	Transformers	

RDA Reg No. RDASR **1026**

45 **Sumathi Information Technologies (Pvt) Ltd** Specilized Products / Brands Business Reg. No PV417

No.491, Galle rd, Colombo 03

0773887013/0115553311

0115553312

info@sit.lk

Pix4D	TRD	Rafael Advanced
-	-	

RDA Reg No. RDASR **1035**

46 **Energynet (Pvt) Ltd** Specilized Products / Brands Business Reg. No PV6443

180, Deans Rd, Colombo 10

0112448518

0112448517

info@hayleysfentons.com

Vertiv	Tescom	-
-	-	

RDA Reg No. RDASR **1041**

47 **Computer Land** Specilized Products / Brands Business Reg. No WP12982

No.86/3, Kurunda Watta rd, Pitakotte

0777636708

-

computerland321@gmail.com

-	-	-
-	-	

RDA Reg No. RDASR **01058**

1.5 Convertainer Boxex

1 **Tillmax Pvt Ltd**

Specilized Products / Brands

Business Reg. No PV7042



No.140/1, Kethsiri Sevana, Thumbowila, Piliyandala

-	-	-
-	-	



0117355355



.117355350



info@tillmax.lk

RDA Reg No.

RDASR **0039**

1.6 Drawing and Design Equipment

1 Mahajana Hardware

Specilized Products / Brands

Business Reg. No NCP0025



No.90, Main Street, Anuradhaoura

-	-	-
-	-	



0252223901



0252223902



nazeer.mahajana@gmail.com

RDA Reg No.

RDASR 0053

1.7 Drinking Water Bottles

1 **T.D.R.Engineering and Construction**

Specilized Products / Brands

Business Reg. No 3917



No.08, Good Shed Rd, Rathnapura

-	-	-
-	-	



0717850600



0452222118



























tdengineeringc@gmail.com

RDA Reg No.

RDASR 0817

1.8 Electrical Equipment & Accessories

1	SM International (PTE0LTD)	Specilized Products / Brands	Business Reg. No	PV16190						
	No.9, Dakshinarama Rd, Mount Lavinia	<table border="1"><tr><td>-</td><td>-</td><td>-</td></tr><tr><td>-</td><td>-</td><td>-</td></tr></table>	-	-	-	-	-	-		
-	-	-								
-	-	-								
	0112733198/199									
	0112733043									
	admin@smintel.net		RDA Reg No.	RDASR 0016						
2	Rovel Lanka (Pvt) Ltd	Specilized Products / Brands	Business Reg. No	PV94692						
	90/B/2,Horana Rd, Katuwawala, Boralesgamuwa	<table border="1"><tr><td>-</td><td>-</td><td>-</td></tr><tr><td>-</td><td>-</td><td>-</td></tr></table>	-	-	-	-	-	-		
-	-	-								
-	-	-								
	0115998899									
	0115998898									
	info@rovel.lk		RDA Reg No.	RDASR 0022						
3	Rio Electrical & Gems	Specilized Products / Brands	Business Reg. No	CPC/KY637						
	161,SW Bandaranayake Mw, Kandy	<table border="1"><tr><td>-</td><td>-</td><td>-</td></tr><tr><td>-</td><td>-</td><td>-</td></tr></table>	-	-	-	-	-	-		
-	-	-								
-	-	-								
	0812232519									
	0814471175									
	rioelectricals@gmail.com		RDA Reg No.	RDASR 0051						
4	Telesonic Lanka (Pvt) Ltd	Specilized Products / Brands	Business Reg. No	PV92020						
	No.18, Daisy Villa Avenue, R.A.De Mel Mawatha, Colombo - 04	<table border="1"><tr><td>Telesonic</td><td>Midea</td><td>-</td></tr><tr><td>-</td><td>-</td><td>-</td></tr></table>	Telesonic	Midea	-	-	-	-		
Telesonic	Midea	-								
-	-	-								
	0112508160/2									
	0112508182									
	sales@telesoniclanka.com		RDA Reg No.	RDASR 0071						
5	C.W.Mackie PLC	Specilized Products / Brands	Business Reg. No							
	IPD, No.36, D.R.Wijewardana Mw, Colombo 10	<table border="1"><tr><td>E.30</td><td>1.8</td><td>1.34</td></tr><tr><td>1.38</td><td>1.39</td><td>-</td></tr></table>	E.30	1.8	1.34	1.38	1.39	-		
E.30	1.8	1.34								
1.38	1.39	-								
	0112423554-62									
	0112331100									
	sales@ipd.cwmackie.com/ipd@cwmackie.		RDA Reg No.	RDASR 0107						
6	Kelani Cables PLC	Specilized Products / Brands	Business Reg. No							
	PO Box 14, Wewelduwa, Kelaniya	<table border="1"><tr><td>Cables-Power</td><td>-</td><td>-</td></tr><tr><td>-</td><td>-</td><td>-</td></tr></table>	Cables-Power	-	-	-	-	-		
Cables-Power	-	-								
-	-	-								
	0112911224									
	0112910481									
	projects4@kelanicables.com		RDA Reg No.	RDASR 0117						

1.8 Electrical Equipment & Accessories

7 **ABC Electricals**
 83/12, First Cross Street, Colombo 11
 0112335859/0112542039
 0112424504
 abcelectricals@sltnet.lk

Specilized Products / Brands

Business
Reg. No

ACL Cables	Orange Lighting	Orange Cables
Orange Electricals	Green Electricals	

RDA Reg No. RDASR **0147**





8 **Siegn Corporation (Pvt) Ltd**
 No.284/A, Galle Rd, Rawathawatta,
Moratuwa
 0112461462/0722303355
 -
 info@siegen.lk

Specilized Products / Brands

Business
Reg. No

-	-	-
-	-	

RDA Reg No. RDASR **0148**





9 **U.K.Electricals**
 No.44/1, 46/48, First Cross Street,
Colombo 11
 0112471440/0112445001
 0112326040
 ukelectricals25@hotmail.com/ukelectricals

Specilized Products / Brands

Business
Reg. No

-	-	-
-	-	

RDA Reg No. RDASR **0150**

10 **U.K.Electricals**
 No.44/1, 46/48, First Cross Street,
Colombo 11
 0112471440/0112445001
 0112326040
 ukelectricals25@hotmail.com/ukelectricals

Specilized Products / Brands

Business
Reg. No

-	-	-
-	-	

RDA Reg No. RDASR **0150**

11 **Nativeway (Pvt) Ltd**
 No.549, Sri Sangaraja Mw, Colombo 10
 0112030730/0773370742
 0112336802
 tenders@nativeway.lk/info@nativeway.lk

Specilized Products / Brands

Business
Reg. No

Person Generator	Cooper Generator	Lutan Generator
Tripho Generator	water Pumps	

RDA Reg No. RDASR **0187**

12 **Rohan Rodrigo Refrigeration & Air
Conditioning Co. Pvt Ltd**
 No.217, union Place, Colombo 02
 0112334721
 0112334726
 nuwamrod@gmail.com

Specilized Products / Brands

Business
Reg. No



-	-	-
-	-	

RDA Reg No. RDASR **0205**

1.8 Electrical Equipment & Accessories

13 **ACL Cables PLC** Business Reg. No

 No.60, Rodney Street, Colombo 08



 0117608300
 0112699503
 tenders@acl.lk

Specilized Products / Brands		
PVC Cables	XLPE Insulated Cables	Unarmoured Cables
Armoured Cables	-	

RDA Reg No. RDASR 0241

14 **Micro Channel Lanka (Pvt) Ltd** Business Reg. No

 No.165D, New Kalmunai, Batticaloa



 0762339997/0773201786/0777710086/07
 0652224646
 info@mclpvt.lk

Specilized Products / Brands		
-	-	-
-	-	

RDA Reg No. RDASR 0261

15 **Ambro Electricals** Business Reg. No

 No.92, First Cross Street, Colombo 11



 0112423808/0112458562
 0112327923
 ambroel@sltnet.lk

Specilized Products / Brands		
-	-	-
-	-	

RDA Reg No. RDASR 0269

16 **Winway Engineering (Pvt) Ltd** Business Reg. No

 200/38/D2, William Jayasooriya Mw, Bandaragama Rd, Kesbewa



 0112620522/0114304470
 0112620522
 winwayeng@gmail.com

Specilized Products / Brands		
-	-	-
-	-	

RDA Reg No. RDASR 0361

17 **Galle Electrical Agencies (Pvt) Ltd** Business Reg. No

 No.71, Yatinuwara Veediya, Kandy



 0812224473
 08122375051
 galleelectrical71@gmail.com

Specilized Products / Brands		
-	-	-
-	-	

RDA Reg No. RDASR 0408

18 **Telesonic Lanka (Pvt) Ltd** Business Reg. No























 No.18, Daisy Villa Avenue, R.A.De Mel Mawatha, Colombo - 04

 0112508160
 0112501726
 ac.public@telesoniclanka.com

























Specilized Products / Brands		
All Condition ers	-	-
-	-	

RDA Reg No. RDASR 0423

1.8 Electrical Equipment & Accessories

19	John Keells Office Automation (Pvt) Ltd  No.90, Union Place, Colombo 02  0112313000  0112431745  jkoa@keells.com	Specilized Products / Brands <table border="1"> <tbody> <tr> <td>ASUS Desktop</td> <td>ASUS Laptop</td> <td>Posmoba Photocopi or</td> </tr> <tr> <td>viewsonic Multimed</td> <td>Samsung</td> <td></td> </tr> </tbody> </table>	ASUS Desktop	ASUS Laptop	Posmoba Photocopi or	viewsonic Multimed	Samsung		Business Reg. No RDA Reg No. RDASR 0429
ASUS Desktop	ASUS Laptop	Posmoba Photocopi or							
viewsonic Multimed	Samsung								
20	Listec Holdings (Pvt) Ltd  No.74/3/1, Sri Sangaraja Mw, Colombo 10  0114191377/0777896601  -  lalith@listecholdings.com	Specilized Products / Brands <table border="1"> <tbody> <tr> <td>Sunk Box</td> <td>Electrical Item</td> <td>Electronic Item</td> </tr> <tr> <td>-</td> <td>-</td> <td></td> </tr> </tbody> </table>	Sunk Box	Electrical Item	Electronic Item	-	-		Business Reg. No RDA Reg No. RDASR 0433
Sunk Box	Electrical Item	Electronic Item							
-	-								
21	Galle City Suppliers (Pvt) Ltd  No.69, Main Street, Kaduruwela  0272056205  -  gallecitystores7@gmail.com	Specilized Products / Brands <table border="1"> <tbody> <tr> <td>-</td> <td>-</td> <td>-</td> </tr> <tr> <td>-</td> <td>-</td> <td></td> </tr> </tbody> </table>	-	-	-	-	-		Business Reg. No RDA Reg No. RDASR 0450
-	-	-							
-	-								
22	Metro Electricals (Pvt) Ltd  No.32,34,1st Cross Street, Colombo 11  0114379520-21/0112435116  0112327656  metroepl@sltnet.lk	Specilized Products / Brands <table border="1"> <tbody> <tr> <td>-</td> <td>-</td> <td>-</td> </tr> <tr> <td>-</td> <td>-</td> <td></td> </tr> </tbody> </table>	-	-	-	-	-		Business Reg. No RDA Reg No. RDASR 0551
-	-	-							
-	-								
23	Nec Technologies  No.58, New Town, Rathnapura  0452228162  0452050877  82nectechnologies@gmail.com	Specilized Products / Brands <table border="1"> <tbody> <tr> <td>Toner, Cartridge</td> <td>Ribben</td> <td>Computer s, Laptops</td> </tr> <tr> <td>Photocop y Machine</td> <td>Fax Machine</td> <td></td> </tr> </tbody> </table>	Toner, Cartridge	Ribben	Computer s, Laptops	Photocop y Machine	Fax Machine		Business Reg. No RDA Reg No. RDASR 0603
Toner, Cartridge	Ribben	Computer s, Laptops							
Photocop y Machine	Fax Machine								
24	Rankine Cool air  No.150/4, King Street, Matale  0662231355  -  rankinecoolair@yahoo.com	Specilized Products / Brands <table border="1"> <tbody> <tr> <td>-</td> <td>-</td> <td>-</td> </tr> <tr> <td>-</td> <td>-</td> <td></td> </tr> </tbody> </table>	-	-	-	-	-		Business Reg. No RDA Reg No. RDASR 0835
-	-	-							
-	-								

1.8 Electrical Equipment & Accessories

25	Abans PLC	Specilized Products / Brands	Business Reg. No						
	No.498, Galle rd, Colombo 03	<table border="1"> <tr> <td>All Conditioners</td> <td>Refrigerators</td> <td>Fans</td> </tr> <tr> <td>Kettles</td> <td>Equipments</td> <td></td> </tr> </table>	All Conditioners	Refrigerators	Fans	Kettles	Equipments		
All Conditioners	Refrigerators	Fans							
Kettles	Equipments								
	0112776978/01157750910/0112565292								
	0115936364/0114512440/0114512506								
	janaranga@abansgroup.com/projects@ab	RDA Reg No.	RDASR 0853						
26	Metropolitan Technologies (Pvt) Ltd	Specilized Products / Brands	Business Reg. No						
	No.12, Magazine rd, Colombo 08	<table border="1"> <tr> <td>Omigo-All Conditioners</td> <td>Acer-Computer</td> <td>Printronic-Printers</td> </tr> <tr> <td>Power Engineering</td> <td>Ningbo RDC-Duplicators</td> <td></td> </tr> </table>	Omigo-All Conditioners	Acer-Computer	Printronic-Printers	Power Engineering	Ningbo RDC-Duplicators		
Omigo-All Conditioners	Acer-Computer	Printronic-Printers							
Power Engineering	Ningbo RDC-Duplicators								
	0114700200								
	0114700267								
	salesmal@metropolitan.lk	RDA Reg No.	RDASR 0866						
27	Brown & Company PLC	Specilized Products / Brands	Business Reg. No						
	No.34, Sir Mohamed Macan Markar Mw, Colombo 03	<table border="1"> <tr> <td>-</td> <td>-</td> <td>-</td> </tr> <tr> <td>-</td> <td>-</td> <td></td> </tr> </table>	-	-	-	-	-		
-	-	-							
-	-								
	0115063280								
	0112307377								
	procurement@brownsgroup.com	RDA Reg No.	RDASR 0736						
28	Central Electrical Lanka (Pvt) Ltd	Specilized Products / Brands	Business Reg. No						
	No.80,82 Maliban Street, Colombo 11	<table border="1"> <tr> <td>-</td> <td>-</td> <td>-</td> </tr> <tr> <td>-</td> <td>-</td> <td></td> </tr> </table>	-	-	-	-	-		
-	-	-							
-	-								
	0112344316-7/0112435672								
	0112334552								
	centralelec@sltnet.lk	RDA Reg No.	RDASR 0911						
29	Softlogic Retail (Pvt) Ltd	Specilized Products / Brands	Business Reg. No						
	No.402, Level-3, Panasonoc Building, Galle rd, Colombo 03	<table border="1"> <tr> <td>-</td> <td>-</td> <td>-</td> </tr> <tr> <td>-</td> <td>-</td> <td></td> </tr> </table>	-	-	-	-	-		
-	-	-							
-	-								
	0115391100								
	0112375151								
	kusal@softlogic.lk	RDA Reg No.	RDASR 0946						
30	Pubudu Engineering (Pvt) Ltd	Specilized Products / Brands	Business Reg. No						
	No.68, UDA Industrial Estate, Katuwana rd, Homagama	<table border="1"> <tr> <td>-</td> <td>-</td> <td>-</td> </tr> <tr> <td>-</td> <td>-</td> <td></td> </tr> </table>	-	-	-	-	-		
-	-	-							
-	-								
	0112855584/0718545134								
	0114308344								
	roshan@pubududneng.net	RDA Reg No.	RDASR 0966						

1.9 Electronic Equipment (Finger Print/Cash Counting/POS Machines/Bar Corde Readers)

1 **Nichito Technology (Pvt) Ltd** Specilized Products / Brands Business Reg. No PV00208720

27/A, 4th Lane siddamulla, Piliyandala

0113671477

0113671477

nichitotech@gmail.com

-	-	-
-	-	

RDA Reg No. RDASR 0004

2 **Tillmax Pvt Ltd** Specilized Products / Brands Business Reg. No PV7042

No.140/1, Kethsiri Sevana, Thumbowila, Piliyandala

0117355355

.117355350

info@tillmax.lk

-	-	-
-	-	

RDA Reg No. RDASR 0039

3 **VS Information Systems (Pvt) Ltd** Specilized Products / Brands Business Reg. No PV66809

No.07, suleiman Terrace, Colombo 05

0112038500

0112555805

marketingsupport@vsis.lk/sales@vsis.lk

-	-	-
-	-	

RDA Reg No. RDASR 0067

4 **Electroscales and Equipment** Specilized Products / Brands Business Reg. No W/A21744

146/11C, Caldera Gardens, Dutugmunu Street, Kohuwela

0112817659/0112818042

0112817658

scales@sltnet.lk

Laboratory and material	All types of Electronic	0
-	-	

RDA Reg No. RDASR 0156

5 **Super Unique International (Pvt) Ltd** Specilized Products / Brands Business Reg. No

509, Colombo Rd, Negombo

0312228150/0701308634

0312228150

inquires@superuniqueit.com/sales@smartl

-	-	-
-	-	

RDA Reg No. RDASR 0170

6 **DPJ Holdings** Specilized Products / Brands Business Reg. No

DPJ House, Pichchamal Udyanaya, Narahenpita Rs, Nawala

0115227227

0115369248

reception@dpjh.com

-	-	-
-	-	

RDA Reg No. RDASR 0232

1.9 Electronic Equipment (Finger Print/Cash Counting/POS Machines/Bar Code Readers)

7 Micro Channel Lanka (Pvt) Ltd

Specilized Products / Brands

Business
Reg. No

No.165D, New Kalmunai, Batticaloa

-	-	-
-	-	

0762339997/0773201786/0777710086/076

0652224646

info@mclpvt.lk

RDA Reg No.

RDASR 0261

8 Lakmuthu IT Solutions

Specilized Products / Brands

Business
Reg. No

St. Mary's rd, Chilaw

Hikvision	-	-
-	-	

0322221210

-

office@lakmuthu.com

RDA Reg No.

RDASR 0403

9 EKRAIN Holdings

Specilized Products / Brands

Business
Reg. No

578A, Colombo Rd, New Town, Rathnapura

Finger Print	-	-
-	-	

0452233325

0452233325

poornika@ekrainholdings.com

RDA Reg No.

RDASR 0421

10 John Keells Office Automation (Pvt) Ltd

Specilized Products / Brands

Business
Reg. No

No.90, Union Place, Colombo 02

ASUS Desktop	ASUS Laptop	Toshiba Photocopi er
viewsonic Multimedi a	Samsung	

0112313000

0112431745

jkoa@keells.com

RDA Reg No.

RDASR 0429

11 Ceylon Business Appliances (Pvt) Ltd

Specilized Products / Brands

Business
Reg. No

No.112, Reid Avenue, Colombo 04

Densimet ers	-	-
-	-	

0117845300

0112503121

sales@cba.lk

RDA Reg No.

RDASR 0451

12 Sashira International

Specilized Products / Brands

Business
Reg. No

No.185 T, Rathna Mw, Niwanthidiya, Piliyandala

Steel Furniture	Fiber Cables	Fusion Splicing Machine
Telecom municatio n	All Type Connector s	

0112819770/1

0112819772

sashira-int@slt.net.lk

RDA Reg No.

RDASR 0456

1.9 Electronic Equipment (Finger Print/Cash Counting/POS Machines/Bar Corde Readers)

13 **C.S.Enterprises** Specilized Products / Brands Business Reg. No

 No.414/1, Godage Mw, Anuradhapura

 0718723000/0254580628

 0252227147

 ccenterprises18@gmail.com

ID Card Printer	-	-
-	-	-

RDA Reg No. RDASR **0558**

14 **K.N.C.Computer Technologies Pvt ltd** Specilized Products / Brands Business Reg. No

 No.21 A, Station Rd, Matara

 04122342222

 0412234222

 knccomputer@gmail.com

-	-	-
-	-	-

RDA Reg No. RDASR **0653**

15 **Metropolitan Technologies (Pvt) Ltd** Specilized Products / Brands Business Reg. No

 No.12, Magazine rd, Colombo 08

 0114700200

 0114700267

 salesmal@metropolitan.lk

Chigo-Air Condition	ACER-Computer	Printronic-Printers
Power Engineeri	Nirfgoo RDC-Duplicators	

RDA Reg No. RDASR **0866**

16 **Debug Computer Peripherals (Pvt) Ltd** Specilized Products / Brands Business Reg. No

 No.58, 42nd Lane, Wellawatta, Colombo 06

 0117520000

 0112362612/0112589597

 corporate@debugisp.net/sanjeewaw2debug

DCP	EPSON	KYOCER A
BENQ	SOPHOS	

RDA Reg No. RDASR **0769**

17 **Softlogic Retail (Pvt) Ltd** Specilized Products / Brands Business Reg. No

 No.402, Level-3, Panasonoc Building, Galle rd, Colombo 03

 0115391100

 0112375151

 kusal@softlogic.lk

-	-	-
-	-	-

RDA Reg No. RDASR **0946**

18 **Business Machines Co. (Pvt) Ltd** Specilized Products / Brands Business Reg. No

 No.1,Lake Crescent, Colombo 02

 0112304380

 0112304381

 info@biz-machines.com

-	-	-
-	-	-

RDA Reg No. RDASR **0972**

1.9 Electronic Equipment (Finger Print/Cash Counting/POS Machines/Bar Corde Readers)

19 Vanoj Office Automation



561/40,Preeman Mw, Anuradhapura



0254580054



0252226900



vanojoffice@gmail.com

Specilized Products / Brands

Photo copier	Fax machin	Laptop
Computer s	Toner, Cartridge	

Business Reg. No

RDA Reg No.

RDASR 1014

20 Office Equipment PLC



No.20, Sir Chittampalam A. Gardiner Mw, Colombo 02



0112327659/0112434161-3



0112348399



samanagmoe@sltnet.lk

Specilized Products / Brands

NOTE Counting/Sorting Machine/Date Stamping M/C	COIN Counting-Sorting Recording Machines	Strapping Machine
---	--	-------------------

Business Reg. No

RDA Reg No.

RDASR 1008

21 Fentons Ltd



180, Deans rd, Colombo 10



0112448518



0112448517



info@hayleysfentons.com

Specilized Products / Brands

NEC	Bosch	Carrier
Gree	-	

Business Reg. No

RDA Reg No.

RDASR 1042

1.10 Facsimile, Telephones, Calculators & Communication

Equipment (Finger Print/Cash Counting/POS Machines/Bar Code Readers)

1	Tillmax Pvt Ltd	Specilized Products / Brands	Business Reg. No	PV7042						
	No.140/1, Kethsiri Sevana, Thumbowila, Piliyandala	<table border="1"> <tr> <td>-</td> <td>-</td> <td>-</td> </tr> <tr> <td>-</td> <td>-</td> <td>-</td> </tr> </table>	-	-	-	-	-	-		
-	-	-								
-	-	-								
	0117355355									
	.117355350									
	info@tillmax.lk		RDA Reg No.	RDASR 0039						

2	Call Lanka Telecom (Pvt) Ltd	Specilized Products / Brands	Business Reg. No	PV13180						
	No.10/6, Dewananda Rd, Nawinna, Maharagama	<table border="1"> <tr> <td>Dahua</td> <td>NEC</td> <td>Hikvision</td> </tr> <tr> <td>CP Plus</td> <td>-</td> <td>-</td> </tr> </table>	Dahua	NEC	Hikvision	CP Plus	-	-		
Dahua	NEC	Hikvision								
CP Plus	-	-								
	0112810540									
	0112803805									
	calllanka@shnet.lk		RDA Reg No.	RDASR 0116						

3	John Keells Office Automation (Pvt) Ltd	Specilized Products / Brands	Business Reg. No	PV127407						
	No.90, Union Place, Colombo 02	<table border="1"> <tr> <td>ASUS Desktop</td> <td>ASUS Laptop</td> <td>Toshiba Photocopi</td> </tr> <tr> <td>viewsonic Multimed</td> <td>Samsung</td> <td>-</td> </tr> </table>	ASUS Desktop	ASUS Laptop	Toshiba Photocopi	viewsonic Multimed	Samsung	-		
ASUS Desktop	ASUS Laptop	Toshiba Photocopi								
viewsonic Multimed	Samsung	-								
	0112313000									
	0112431745									
	jkoa@keells.com		RDA Reg No.	RDASR 0429						

4	Ceylon Business Appliances (Pvt) Ltd	Specilized Products / Brands	Business Reg. No	PV791						
	No.112, Reid Avenue, Colombo 04	<table border="1"> <tr> <td>Densimet ers</td> <td>-</td> <td>-</td> </tr> <tr> <td>-</td> <td>-</td> <td>-</td> </tr> </table>	Densimet ers	-	-	-	-	-		
Densimet ers	-	-								
-	-	-								
	0117845300									
	0112503121									
	sales@cba.lk		RDA Reg No.	RDASR 0451						

5	Neat Lanka Pvt Ltd	Specilized Products / Brands	Business Reg. No							
	No.455/1/A, Galle rd, Colombo 06	<table border="1"> <tr> <td>-</td> <td>-</td> <td>-</td> </tr> <tr> <td>-</td> <td>-</td> <td>-</td> </tr> </table>	-	-	-	-	-	-		
-	-	-								
-	-	-								
	0115565000/0777326720/0773979783									
	0112500704									
	neatk@slt.lk		RDA Reg No.	RDASR 0693						

6	Metropolitan Technologies (Pvt) Ltd	Specilized Products / Brands	Business Reg. No							
	No.12, Magazine rd, Colombo 08	<table border="1"> <tr> <td>Condition</td> <td>Computer</td> <td>Printronic-Printers</td> </tr> <tr> <td>Engineeri</td> <td>RDC-</td> <td>-</td> </tr> </table>	Condition	Computer	Printronic-Printers	Engineeri	RDC-	-		
Condition	Computer	Printronic-Printers								
Engineeri	RDC-	-								
	0114700200									
	0114700267									
	salesmal@metropolitan.lk		RDA Reg No.	RDASR 0866						



1.10 Facsimile, Telephones, Calculators & Communication

Equipment (Finger Print/Cash Counting/POS Machines/Bar Code Readers)

7 **Debug Computer Peripherals (Pvt) Ltd** Specilized Products / Brands Business Reg. No

 No.58, 42nd Lane, Wellawatta, Colombo 06



DCP	EPSON	KYOCER A
BENQ	SOPHOS	

 0117520000
 0112362612/0112589597
 corporate@debugisp.net/sanjeewaw2debug RDA Reg No. **RDASR 0769**

8 **Packsco Ceylon (Pvt) Ltd** Specilized Products / Brands Business Reg. No

 No.19, St. Michal's rd, Colombo 03



-	-	-
-	-	

 0112343100-1
 0112343103
 info@packsco.lk RDA Reg No. **RDASR 0942**

9 **Softlogic Retail (Pvt) Ltd** Specilized Products / Brands Business Reg. No

 No.402, Level-3, Panasonoc Building, Galle rd, Colombo 03



-	-	-
-	-	

 0115391100
 0112375151
 kusal@softlogic.lk RDA Reg No. **RDASR 0946**

10 **Business Machines Co. (Pvt) Ltd** Specilized Products / Brands Business Reg. No

 No.1,Lake Crescent, Colombo 02

-	-	-
-	-	

 0112304380
 0112304381
 info@biz-machines.com RDA Reg No. **RDASR 0972**

11 **Vanoj Office Automation** Specilized Products / Brands Business Reg. No





 561/40,Preeman Mw, Anuradhapura



Photo copier	Fax machin	Laptop
Computer s	Toner, Cartridge	

 0254580054
 0252226900
 vanojooffice@gmail.com RDA Reg No. **RDASR 1014**













12 **Fentons Ltd** Specilized Products / Brands Business Reg. No

 180, Deans rd, Colombo 10





NEC	Bosch	Carrier
Gree	-	





 0112448518
 0112448517
 info@hayleysfentons.com RDA Reg No. **RDASR 1042**





1.11 Gate Controller Units & Power Supply Units/Loop Sensors





1	Browns Engineering and Construction (Pvt) Ltd	Specilized Products / Brands	Business Reg. No	PV129313						
	 No.481, T.B.Jayah Mw, Colombo 10	<table border="1"> <tr> <td>-</td> <td>-</td> <td>-</td> </tr> <tr> <td>-</td> <td>-</td> <td></td> </tr> </table>	-	-	-	-	-			
-	-	-								
-	-									
	 0117644525									
	 0117644548									
	 bec@brownsinvestments.com		RDA Reg No.	<table border="1"> <tr> <td>RDASR</td> <td>0142</td> </tr> </table>	RDASR	0142				
RDASR	0142									
2	4M International (Pvt) Ltd	Specilized Products / Brands	Business Reg. No	PV98050						
	 No.137, High level Rd, Kendalanda, Homagama	<table border="1"> <tr> <td>-</td> <td>-</td> <td>-</td> </tr> <tr> <td>-</td> <td>-</td> <td></td> </tr> </table>	-	-	-	-	-			
-	-	-								
-	-									
	 0112098417									
	 0112098417									
	 info@4minternational.lk/info@4minternation		RDA Reg No.	<table border="1"> <tr> <td>RDASR</td> <td>0188</td> </tr> </table>	RDASR	0188				
RDASR	0188									
3	Sashira International	Specilized Products / Brands	Business Reg. No	WJ6281						
	 No.185 T, Rathna Mw, Niwanthidiya, Piliyandala	<table border="1"> <tr> <td>Steel Furniture</td> <td>Fiber Cables</td> <td>Fusion Splicing</td> </tr> <tr> <td>Telecom municatio</td> <td>Air type Connector</td> <td></td> </tr> </table>	Steel Furniture	Fiber Cables	Fusion Splicing	Telecom municatio	Air type Connector			
Steel Furniture	Fiber Cables	Fusion Splicing								
Telecom municatio	Air type Connector									
	 0112819770/1									
	 0112819772									
	 sashira-int@sltnet.lk		RDA Reg No.	<table border="1"> <tr> <td>RDASR</td> <td>0456</td> </tr> </table>	RDASR	0456				
RDASR	0456									





1.12 Laboratory Material, Tools, Accessories, Chemicals and Hardware Items





1	Piyasasa and Sons  No.34, Galwala Rd, Colombo 12  0112435871/0112321324  0112440181  piyadasasons2018@gmail.com	Specilized Products / Brands			Business Reg. No	W4069
		-	-	-		
		-	-			
				RDA Reg No.	RDASR 0026	

2	Willpower Industrial Solutions Pvt Ltd  B9/SP, YMBA Building, No.70, D.S.Senanayaka Mw, Colombo 08  0114610969  0112685909  info@willpowersl.com	Specilized Products / Brands			Business Reg. No	PV00234201
		-	-	-		
		-	-			
				RDA Reg No.	RDASR 0018	

3	Colombo Chemicals  157/31A, Godaparagahawatta, Honnanthara, Piliyandala  0773149623  0382288748  colombochemicals@hotmail.com	Specilized Products / Brands			Business Reg. No	W/J1659
		-	-	-		
		-	-			
				RDA Reg No.	RDASR 0059	

4	Pryda Enterprise  No.03, Abdul Hameed Street, Colombo 12  0112321325/0112321023  0112440181  prydalk@gmail.com/pryda.info@gmail.com	Specilized Products / Brands			Business Reg. No	WA205539
		-	-	-		
		-	-			
				RDA Reg No.	RDASR 0095	

5	Electroscales and Equipment  146/11C, Caldera Gardens, Dutugmunu Street, Kohuwela  0112817659/0112818042  0112817658  scales@sltnet.lk	Specilized Products / Brands			Business Reg. No	
		Laborator y and	All Types of	0		
		-	-			
				RDA Reg No.	RDASR 0156	

6	Islandwide Scientific (Pvt) Ltd  No.19A, Fairfield Garden, Colombo 08  0112681147-9  0112696663  islandwide@slt.lk	Specilized Products / Brands			Business Reg. No	
		-	-	-		
		-	-			
				RDA Reg No.	RDASR 0207	

1.12 Laboratory Material, Tools, Accessories, Chemicals and Hardware Items

7 S & D Associates

No.36, Oid Kesbewa Rd, Raththanapitiya, Boralesgamuwa

0114515544

0114515545

miclab@sdchemlanka.com

Specilized Products / Brands

Business Reg. No

Hanna	afl Roth	Ssi Bio
Abm	Labtton	

RDA Reg No. RDASR 0399

8 Sashira International

No.185 T, Rathna Mw, Niwanthidiya, Piliyandala

0112819770/1

0112819772

sashira-int@sltnet.lk

Specilized Products / Brands

Business Reg. No

Steel Furniture	Fiber Cables	Fusion Splicing
Telecom municatio	All Type Connector	

RDA Reg No. RDASR 0456

9 Analytical Instruments (Pvt) Ltd

No.100, Elvitigala Mw, Colombo 08

0112639000

0112699282

analytical@aipl.lk

Specilized Products / Brands

Business Reg. No

-	-	-
-	-	

RDA Reg No. RDASR 0490

10 Ontarc (Pvt) Ltd

137, Mahena Rd, Siyambalape

0114740954

0114740954

ontarc@sltnet.lk

Specilized Products / Brands

Business Reg. No

-	-	-
-	-	

RDA Reg No. RDASR 0489

11 Research Instruments Pvt Ltd

No.140 2/1, P.O.Box: 45, Galle Rd, Mount Lavinia

0115708001

0115708002

info@researchinstruments.lk

Specilized Products / Brands

Business Reg. No

Total Stations	Theodolite Etc.	Laboratory
Glassware	Chemicals	

RDA Reg No. RDASR 0609

12 T.D.R.Engineering and Construction

No.08, Good Shed Rd, Rathnapura

0717850600

0452222118

tdengineeringc@gmail.com

Specilized Products / Brands

Business Reg. No

-	-	-
-	-	

RDA Reg No. RDASR 0817

1.12 Laboratory Material, Tools, Accessories, Chemicals and Hardware Items

13 Trident Holdings (Pvt) Ltd

No.63/1, Maharagama rd, Boralessgamuwa

0112715657

0112150806

info@tridentholdings.lk

Specilized Products / Brands

Borehole Drilling Machine	Survey Equipmen ts	Core Drilling Accessori
0	-	

Business
Reg. No

RDA Reg No.

RDASR 0733

14 Instech (Pvt) Ltd

72/1, , Carlton Residencies, Pepiliyana rd,
Nedimala

0117922665

0117922665

instech.trade@gmail.com

Specilized Products / Brands

Survey Equipmen ts	GPS	Asphalt Testing Equipmen
Soil Testing Equipmen	Concrete Testing Equipmen	

Business
Reg. No

RDA Reg No.

RDASR 0960

15 Scientific Instruments (Pvt) Ltd

No.183/1/1, Maharagama rd,
Borelessgamuwa

0112545494/0112518181

0112545494

logistics@sipl.lk

Specilized Products / Brands

























High Technolo gy	Analytical technique	Centrifuga ration
Constant Tempeatu	Hand Held Test	

Business
Reg. No

RDA Reg No.

RDASR 1010

1.13 LED Street Lights, Road Lanterns, Light Poles etc

1 Evergreen Lighting & Electrical Lanka (Pvt) Ltd	Specilized Products / Brands	Business Reg. No PV90996						
 No.175, Minuwangoda Rd, Ekala	<table border="1"> <tr> <td>-</td> <td>-</td> <td>-</td> </tr> <tr> <td>-</td> <td>-</td> <td>-</td> </tr> </table>	-	-	-	-	-	-	
-	-	-						
-	-	-						
 0712240222/0717270222								
 0112289494								
 rochell@evergreen.lk	RDA Reg No. RDASR 0019							
2 Rio Electrical & Gems	Specilized Products / Brands	Business Reg. No CPC/KY637						
 161,SW Bandaranayake Mw, Kandy	<table border="1"> <tr> <td>-</td> <td>-</td> <td>-</td> </tr> <tr> <td>-</td> <td>-</td> <td>-</td> </tr> </table>	-	-	-	-	-	-	
-	-	-						
-	-	-						
 0812232519								
 0814471175								
 rioelectricals@gmail.com	RDA Reg No. RDASR 0051							
3 Mahajana Hardware	Specilized Products / Brands	Business Reg. No NCP0025						
 No.90, Main Street, Anuradhaoura	<table border="1"> <tr> <td>-</td> <td>-</td> <td>-</td> </tr> <tr> <td>-</td> <td>-</td> <td>-</td> </tr> </table>	-	-	-	-	-	-	
-	-	-						
-	-	-						
 0252223901								
 0252223902								
 nazeer.mahajana@gmail.com	RDA Reg No. RDASR 0053							
4 Overseas Realty Trading (Pvt) Ltd	Specilized Products / Brands	Business Reg. No PV00204310						
 No.18-01, East Tower, World Trade Center, Colombo 01	<table border="1"> <tr> <td>LED Light Fittings</td> <td>-</td> <td>-</td> </tr> <tr> <td>-</td> <td>-</td> <td>-</td> </tr> </table>	LED Light Fittings	-	-	-	-	-	
LED Light Fittings	-	-						
-	-	-						
 0114446333								
 0112449303								
 brianp@ortl.lk	RDA Reg No. RDASR 0119							
5 Browns Engineering and Construction (Pvt) Ltd	Specilized Products / Brands	Business Reg. No						
 No.481, T.B.Jayah Mw, Colombo 10	<table border="1"> <tr> <td>-</td> <td>-</td> <td>-</td> </tr> <tr> <td>-</td> <td>-</td> <td>-</td> </tr> </table>	-	-	-	-	-	-	
-	-	-						
-	-	-						
 0117644525								
 0117644548								
 bec@brownsinvestments.com	RDA Reg No. RDASR 0142							
6 Light Man Technologies (Pvt) Ltd	Specilized Products / Brands	Business Reg. No						
 No.1A, Fransico Place, Moratuwa	<table border="1"> <tr> <td>Street Lights</td> <td>Emergenc y Lights</td> <td>Decorativ e Lights</td> </tr> <tr> <td>Flood Lights</td> <td>Down Lights</td> <td></td> </tr> </table>	Street Lights	Emergenc y Lights	Decorativ e Lights	Flood Lights	Down Lights		
Street Lights	Emergenc y Lights	Decorativ e Lights						
Flood Lights	Down Lights							
 0112649910								
 0112649910								
 harendra.lightman@gmail.com	RDA Reg No. RDASR 0175							

1.13 LED Street Lights, Road Lanterns, Light Poles etc

7 Ligh Box (Pvt) Ltd

No.189, 189/1, Nawala Rd, Nugegoda

0112822868



chandana@lightboxsl.com

Specilized Products / Brands

Business
Reg. No

Light Fittings	Transfromers	Bulbs
-	-	

RDA Reg No.

RDASR **0181**

8 Access International (Pvt) Ltd

"Access Towers", 278, Union Place, Colombo 02

0112302302/0114741857-8

0112302333

ranils@access.lk

Specilized Products / Brands

Business
Reg. No

-	-	-
-	-	

RDA Reg No.

RDASR **0229**

9 Ambro Electricals

No.92, First Cross Street, Colombo 11

0112423808/0112458562

0112327923

ambroel@sltnet.lk

Specilized Products / Brands

Business
Reg. No

-	-	-
-	-	

RDA Reg No.

RDASR **0269**

10 Rotax (Pvt) Ltd

No.332, Galle Road, Colombo 04

0112274000

0112595119

com-rpt@rochegroup.lk/uts-

Specilized Products / Brands

Business
Reg. No

MCB,MCB CB,RCCB ISOLATO Light Fittings	Measurin g Equipmen & Accessori	Cables and Accessori

RDA Reg No.

RDASR **0372**

11 Galle Electrical Agencies (Pvt) Ltd

No.71, Yatinuwara Veediya, Kandy

0812224473

08122375051

galleelectrical71@gmail.com

Specilized Products / Brands

Business
Reg. No

-	-	-
-	-	

RDA Reg No.

RDASR **0408**

12 Sashira International

No.185 T, Rathna Mw, Niwanthidiya, Piliyandala

0112819770/1

0112819772

sashira-int@sltnet.lk

Specilized Products / Brands

Business
Reg. No

Steel Furniture Telecom municatio n	Fiber Cables Air Type Connector s	Fusion Splicing Machine

RDA Reg No.

RDASR **0456**

1.13 LED Street Lights, Road Lanterns, Light Poles etc

13 Diesel & Motor Engineering PLC

 No.65, Jethamana Rd, Colombo 14

 0112449797/0112338883

 0112449080

 dimo@dimolanka.com

Specilized Products / Brands

Business
Reg. No

-	-	-
-	-	

RDA Reg No. RDASR **0476**

14 Verrex (Pvt) Ltd

 No.32/1, Colombo rd, Kurana, Katunayake

 0113685271

 -

 info@verrex.lk

Specilized Products / Brands

Business
Reg. No

1.13	-	-
-	-	

RDA Reg No. RDASR **0557**

15 Asian Electrical

 95A, First Cross Street, Colombo 11

 0112439142/0112439143

 0112338023

 asianelectrical2@gmail.com

Specilized Products / Brands

Business
Reg. No

-	-	-
-	-	

RDA Reg No. RDASR **0627**

16 Metropolitan Technologies (Pvt) Ltd

 No.12, Magazine rd, Colombo 08

 0114700200

 0114700267

 salesmal@metropolitan.lk

Specilized Products / Brands

Business
Reg. No

Chigo-Air Condition Engineeri ng	Acer- Computer Ningbo RDC- Duplicators	Printronic- Printers
---	--	-------------------------

RDA Reg No. RDASR **0866**

17 Pubudu Engineering (Pvt) Ltd

 No.68, UDA Industrial Estate, Katuwana rd,
Homagama

 0112855584/0718545134

 0114308344

 roshan@pubududneng.net

Specilized Products / Brands

Business
Reg. No

-	-	-
-	-	

RDA Reg No. RDASR **0966**

18 Lumizo (Pvt) Ltd

 No.244, Galle rd, Colombo 04

 0112589361/0773220322

 0112589381

 lumizopvtltd@gmail.com

Specilized Products / Brands

Business
Reg. No

-	-	-
-	-	

RDA Reg No. RDASR **0982**

1.13 LED Street Lights, Road Lanterns, Light Poles etc

19 Pramod Electricals



New Tangalle rd, Kotuwegoda, Matara



0412234930



0412232728



pramodelectricalsmt@gmail.com

Specilized Products / Brands

-	-	-
-	-	

Business
Reg. No

RDA Reg No.

RDASR 0986

20 Hayleys Electioncs Ltd



180, Deansrd, Colombo 10



0112448518



0112448517



info@hayleysfentons.com

Specilized Products / Brands

-	-	-
-	-	

Business
Reg. No

RDA Reg No.

RDASR 1040

1.14 Money Detectors

1 #N/A

Specilized Products / Brands

Business
Reg. No

#N/A

 #N/A

#N/A	#N/A	#N/A
#N/A	#N/A	

 #N/A

 #N/A

























 #N/A

RDA Reg No.

RDASR



1.15 Office Furniture

1	Swarnakelum Group (Pvt) Ltd  No.81, Papiliyana Rd, Gangodawila, Nugegoda  0112810716  0112813090  sup@swarnakelum.com	Specilized Products / Brands <table border="1"> <tbody> <tr> <td>-</td> <td>-</td> <td>-</td> </tr> <tr> <td>-</td> <td>-</td> <td>-</td> </tr> </tbody> </table>	-	-	-	-	-	-	Business Reg. No PV15691	RDA Reg No. RDASR 0135
-	-	-								
-	-	-								
2	New Interiors (Pvt) Ltd  No.53/A, Kossinnawatta, Katuwawala, Boralesgamuwa  0117388133/5  0114303636  sales@newint.co	Specilized Products / Brands <table border="1"> <tbody> <tr> <td>-</td> <td>-</td> <td>-</td> </tr> <tr> <td>-</td> <td>-</td> <td>-</td> </tr> </tbody> </table>	-	-	-	-	-	-	Business Reg. No PV17473	RDA Reg No. RDASR 0257
-	-	-								
-	-	-								
3	Galle City Suppliers (Pvt) Ltd  No.69, Main Street, Kaduruwela  0272056205  -  gallecitystores7@gmail.com	Specilized Products / Brands <table border="1"> <tbody> <tr> <td>-</td> <td>-</td> <td>-</td> </tr> <tr> <td>-</td> <td>-</td> <td>-</td> </tr> </tbody> </table>	-	-	-	-	-	-	Business Reg. No PV122771	RDA Reg No. RDASR 0450
-	-	-								
-	-	-								
4	Sashira International  No.185 T, Rathna Mw, Niwanthidiya, Piliyandala  0112819770/1  0112819772  sashira-int@sltnet.lk	Specilized Products / Brands <table border="1"> <tbody> <tr> <td>Steel Furniture</td> <td>Fiber Cables</td> <td>Fusion Splicing Machine</td> </tr> <tr> <td>Telecom municatio</td> <td>Air type Connector</td> <td></td> </tr> </tbody> </table>	Steel Furniture	Fiber Cables	Fusion Splicing Machine	Telecom municatio	Air type Connector		Business Reg. No WJ6281	RDA Reg No. RDASR 0456
Steel Furniture	Fiber Cables	Fusion Splicing Machine								
Telecom municatio	Air type Connector									
5	M.N.Office Automation  No.54, Batticalo rd, Polonnaruwa  0272226757/077305  -  mnoffice76@gmail.com	Specilized Products / Brands <table border="1"> <tbody> <tr> <td>Photocopy Machine</td> <td>Toners</td> <td>Computer s</td> </tr> <tr> <td>Loptops</td> <td>PAINTS</td> <td></td> </tr> </tbody> </table>	Photocopy Machine	Toners	Computer s	Loptops	PAINTS		Business Reg. No PV122771	RDA Reg No. RDASR 0473
Photocopy Machine	Toners	Computer s								
Loptops	PAINTS									
6	Sandamali Timber Depot  No.98, Ketapitiya, Menikdiwela  0772449472  -  asith.kodi@gmail.com	Specilized Products / Brands <table border="1"> <tbody> <tr> <td>Timber</td> <td>Furniture</td> <td>-</td> </tr> <tr> <td>-</td> <td>-</td> <td>-</td> </tr> </tbody> </table>	Timber	Furniture	-	-	-	-	Business Reg. No PV122771	RDA Reg No. RDASR 0695
Timber	Furniture	-								
-	-	-								

1.15 Office Furniture

7 **T.D.R.Engineering and Construction** Specilized Products / Brands Business Reg. No

No.08, Good Shed Rd, Rathnapura

0717850600

0452222118

tdreengineeringc@gmail.com

-	-	-
-	-	

RDA Reg No. RDASR 0817

8 **Metropolitan Technologies (Pvt) Ltd** Specilized Products / Brands Business Reg. No

No.12, Magazine rd, Colombo 08

0114700200

0114700267

salesmal@metropolitan.lk

Chigo-Air Condition	Acer- Computer	Printronic- Printers
Power Engineeri	Ningbo RDC-	

RDA Reg No. RDASR 0866

9 **Alpha Industries (Pvt) Ltd** Specilized Products / Brands Business Reg. No

No.49/16, Iceland Building, Galle rd, Colombo 03

0115707707 - Ext 784

0115707787

info@alpha.lk

Office Furnitures	-	-
-	-	

RDA Reg No. RDASR 0740

10 **S/L State Trading (General0 Corporation Ltd** Specilized Products / Brands Business Reg. No

No.100, Nawam Mw, Colombo 02

0112422342/4

0112447970

lankagen@sltnet.lk

Nano mask	STC Mask	STC Sanitizers
-	-	

RDA Reg No. RDASR 0881

11 **Leema Creations (Pvt) ltd** Specilized Products / Brands Business Reg. No

No.112/2, H.Sri Nissanka Mw, (Maya Avenue), Colombo08

0112422875

0112587346

sales@leema.lk

-	-	-
-	-	

RDA Reg No. RDASR 0905

12 **Enex Agencies (Pvt) Ltd** Specilized Products / Brands Business Reg. No

No.29A, Sri Premarathana Mw, Morarumulla, Moratuwa

0112653203

0112652693

enexfoam@hotmail.com

Enexfoam	Enex Bond	Enex Fix
-	-	

RDA Reg No. RDASR 0781

1.15 Office Furniture

13 **Softlogic Retail (Pvt) Ltd**

 No.402, Level-3, Panasonoc Building, Galle rd, Colombo 03

 0115391100

 0112375151

 kusal@softlogic.lk

Specilized Products / Brands

-	-	-
-	-	

Business
Reg. No

RDA Reg No.

RDASR **0946**

14 **redhi House Tangalle**

 No.112/1/1, Tissa rd, Tangalle

 0718210566

 -

 mikram869@gmail.com

Specilized Products / Brands

-	-	-
-	-	

Business
Reg. No

RDA Reg No.

RDASR **01057**

1.16 Office Stationery & Consumbles

1 L.H.Chandrasekara & Brothers (Pvt) Ltd Specilized Products / Brands Business Reg. No PV9290

No.80, King's Street, Kandy

0812234270/0812228527/0814479437

0814470398

info@chandrasekaragroup.com

-	-	-
-	-	

RDA Reg No. RDASR 0025

2 Central Stationeries Specilized Products / Brands Business Reg. No MPS/DS/5/5/7200

189, Colombo Street, Kandy

0812222045/0812205157

0812205157

centralstationeriesk@gmail.com

-	-	-
-	-	

RDA Reg No. RDASR 0027

3 Soorya Stationers Specilized Products / Brands Business Reg. No WA40154

No. 5, 2nd Rohini Lane, Malwatta Rd, Colombo -11

0112437926/0115673018

0112451343/0114713989

sooryato19@gmail.com

-	-	-
-	-	

RDA Reg No. RDASR 0078

4 Agra Stationers (Pvt) Ltd Specilized Products / Brands Business Reg. No PV00201129

136A, Dam Street, Colombo 12

0115662254/0777485007

0112337800

ramee_agra@hotmail.com

-	-	-
-	-	

RDA Reg No. RDASR 0114

5 Rainbow Stationery & Electrical Specilized Products / Brands Business Reg. No

No.476/1A, Maradana Rd, Colombo 10

0112674262

0112674262

-

-	-	-
-	-	

RDA Reg No. RDASR 0143

6 Spinny Trading Company Specilized Products / Brands Business Reg. No

No.94,First Cross Street,Colombo 11

0112336309/0112422984

0112436473

spinny@sltnet.lk/spinnwy@gmail.com

-	-	-
-	-	

RDA Reg No. RDASR 0204

1.16 Office Stationery & Consumbles

7 Sunshine Stationers

No.112, Bright Plaza, Maliban Street, Colombo 11

0112380389/0777875105

0112380389

info.sunshine stationers

Specilized Products / Brands

-	-	-
-	-	

Business Reg. No

RDA Reg No. RDASR 0206

8 Metro Stationery

40, 1st Floor Maliban Street, Colombo 11

0112445347/0773867192

011445347

info.metro@gmail.com

Specilized Products / Brands

-	-	-
-	-	

Business Reg. No

RDA Reg No. RDASR 0213

9 Pilot Stationers (Pvt) Ltd

No.132, Dam Street, Colombo 12

0112344445/0112433311

0112430718/717

pilot@sltnet.lk/pilot-purchase@sltnet.lk

Specilized Products / Brands

Avalon Ohotocop	Conguero r Board/	Box Files
Tracing Papers	-	

Business Reg. No

RDA Reg No. RDASR 0250

10 Intiaz Packirdeen

No.5, Lower Street, Badulla

0552222497

0552223442

intiazcad@gmail.com

Specilized Products / Brands

-	-	-
-	-	

Business Reg. No

RDA Reg No. RDASR 0405

11 Lakwin Enterprises

No.53, Prince Street, Colombo 11

01125425555/2542556/2424734

0112424733

lakwinent@sltnet.com

Specilized Products / Brands

-	-	-
-	-	

Business Reg. No

RDA Reg No. RDASR 0110

12 Nissico Holding

No.50, Maliban Street, Colombo 11

01123336885/2333141/0777891820

0112333847

nissico@slt.lk

Specilized Products / Brands

-	-	-
-	-	

Business Reg. No

RDA Reg No. RDASR 0430

1.16 Office Stationery & Consumbles

13 Galle City Suppliers (Pvt) Ltd



No.69, Main Street, Kaduruwela



0272056205



-



gallecitystores7@gmail.com

Specilized Products / Brands

Business
Reg. No

-	-	-
-	-	

RDA Reg No.

RDASR **0450**

14 M.N.Office Automation



No.54, Batticalo rd, Polonnaruwa



0272226757/077305



-



mnooffice76@gmail.com

Specilized Products / Brands

Business
Reg. No

Photocop y Machine	Toners	Computer s
Loptops	PAINTS	

RDA Reg No.

RDASR **0473**

15 United Stationary



No.9, Maliban Street, Colombo 11



0112543744/0112345150



0112345150



unitedno09@gmail.com

Specilized Products / Brands

Business
Reg. No

-	-	-
-	-	

RDA Reg No.

RDASR **0517**

16 Taibah Marketing (Pvt) Ltd



No.46/1, Main Street, Nintavur-24



0672250881



0672251219



taibah@sltnet.lk

Specilized Products / Brands

Business
Reg. No

Toshiba Toners	samsung Toners	Canon Toners
Copy Papers	Tishiba Copiers	

RDA Reg No.

RDASR **0563**

17 sealine Trading Company



No.53, Maliban Street, Colombo 11



0112348559



0112473929



sealine@slt.lk

Specilized Products / Brands

Business
Reg. No

-	-	-
-	-	

RDA Reg No.

RDASR **0564**

18 Development Construction & Mechinery Authority



Paradise, Kuruvita



0452262687



0452264199



admin@decma.sg.gov.lk/info@decma.sg.g

Specilized Products / Brands





Business
Reg. No





-	-	-
-	-	





RDA Reg No.





RDASR **0659**





1.16 Office Stationery & Consumbles





19	T.D.R.Engineering and Construction	Specilized Products / Brands	Business Reg. No						
	No.08, Good Shed Rd, Rathnapura	<table border="1"> <tr> <td>-</td> <td>-</td> <td>-</td> </tr> <tr> <td>-</td> <td>-</td> <td></td> </tr> </table>	-	-	-	-	-		
-	-	-							
-	-								
	0717850600								
	0452222118								
	tdengineeringc@gmail.com	RDA Reg No.	RDASR 0817						

20	Metropolitan Technologies (Pvt) Ltd	Specilized Products / Brands	Business Reg. No						
	No.12, Magazine rd, Colombo 08	<table border="1"> <tr> <td>Unigo All Condition</td> <td>ACER Computer</td> <td>Printronic-Printers</td> </tr> <tr> <td>Power Engineeri</td> <td>Unigo RDC-Replicators</td> <td></td> </tr> </table>	Unigo All Condition	ACER Computer	Printronic-Printers	Power Engineeri	Unigo RDC-Replicators		
Unigo All Condition	ACER Computer	Printronic-Printers							
Power Engineeri	Unigo RDC-Replicators								
	0114700200								
	0114700267								
	salesmal@metropolitan.lk	RDA Reg No.	RDASR 0866						

21	S/L State Trading (General) Corporation Ltd	Specilized Products / Brands	Business Reg. No						
	No.100, Nawam Mw, Colombo 02	<table border="1"> <tr> <td>Nano mask</td> <td>STC Mask</td> <td>STC Sanitizers</td> </tr> <tr> <td>-</td> <td>-</td> <td></td> </tr> </table>	Nano mask	STC Mask	STC Sanitizers	-	-		
Nano mask	STC Mask	STC Sanitizers							
-	-								
	0112422342/4								
	0112447970								
	lankagen@slt.net.lk	RDA Reg No.	RDASR 0881						

22	Fakhri Trading Company	Specilized Products / Brands	Business Reg. No						
	No.252, Dam Street, Colombo 12	<table border="1"> <tr> <td>Atlas</td> <td>Panther</td> <td>Promate</td> </tr> <tr> <td>Pieris</td> <td>Nalaka</td> <td></td> </tr> </table>	Atlas	Panther	Promate	Pieris	Nalaka		
Atlas	Panther	Promate							
Pieris	Nalaka								
	0112320644								
	0012470622								
	sales@fakhritrading.lk	RDA Reg No.	RDASR 0898						

23	Packsco Ceylon (Pvt) Ltd	Specilized Products / Brands	Business Reg. No						
	No.19, St. Michal's rd, Colombo 03	<table border="1"> <tr> <td>-</td> <td>-</td> <td>-</td> </tr> <tr> <td>-</td> <td>-</td> <td></td> </tr> </table>	-	-	-	-	-		
-	-	-							
-	-								
	0112343100-1								
	0112343103								
	info@packsco.lk	RDA Reg No.	RDASR 0942						

24	Narah Computer Foems	Specilized Products / Brands	Business Reg. No						
	309/4C, Negombo rd, Welisara	<table border="1"> <tr> <td>-</td> <td>-</td> <td>-</td> </tr> <tr> <td>-</td> <td>-</td> <td></td> </tr> </table>	-	-	-	-	-		
-	-	-							
-	-								
	0112245700-888								
	0112245900/0112230061								
	narahncf@gmail.com	RDA Reg No.	RDASR 0950						

1.16 Office Stationery & Consumbles

25 Printexcel (Pvt) Ltd

 No.164/4A, Bakmeegaswewa rd, Pore, Athurugiriya

 0112562775

 0112562776

 chani.hettiarachchi@promateworld.com

Specilized Products / Brands

Business
Reg. No

BENGN7 75	Sri Lanka Stateslic	People's Bank
Sri Lanka Police	-	

RDA Reg No.

RDASR **0980**

26 Vanoj Office Automation

 561/40,Preeman Mw, Anuradhapura

 0254580054

 0252226900

 vanojooffice@gmail.com

Specilized Products / Brands

























Business
Reg. No

Photo copier	Fax machin	Laptop
Computer s	Toner, Cartridge	

RDA Reg No.

RDASR **1014**

1.17 Photocopy and Printing Machines

1	Shine Tech Solutions  No.375, Bathalohenawatta, Gonawala, Kelaniya  0112715769/0712923105  0115715769  shinetechsolutions@hotmail.com	Specilized Products / Brands <table border="1"> <tbody> <tr> <td>-</td> <td>-</td> <td>-</td> </tr> <tr> <td>-</td> <td>-</td> <td>-</td> </tr> </tbody> </table>	-	-	-	-	-	-	Business Reg. No W26672	RDA Reg No. RDASR 0045
-	-	-								
-	-	-								
2	VS Information Systems (Pvt) Ltd  No.07, suleiman Terrace, Colombo 05  0112038500  0112555805  marketingsupport@vsis.lk/sales@vsis.lk	Specilized Products / Brands <table border="1"> <tbody> <tr> <td>-</td> <td>-</td> <td>-</td> </tr> <tr> <td>-</td> <td>-</td> <td>-</td> </tr> </tbody> </table>	-	-	-	-	-	-	Business Reg. No PV66809	RDA Reg No. RDASR 0067
-	-	-								
-	-	-								
3	Micro Channel Lanka (Pvt) Ltd  No.165D, New Kalmunai, Batticaloa  0762339997/0773201786/0777710086/076  0652224646  info@mclpvt.lk	Specilized Products / Brands <table border="1"> <tbody> <tr> <td>-</td> <td>-</td> <td>-</td> </tr> <tr> <td>-</td> <td>-</td> <td>-</td> </tr> </tbody> </table>	-	-	-	-	-	-	Business Reg. No DS/MN/C/BR /764	RDA Reg No. RDASR 0261
-	-	-								
-	-	-								
4	Reprographics (Pvt) Ltd  No.70, 2nd Floor, Lucky Plaza, St. Anthony's Mw, Colombo 03  0115741975/6  0112372899  rgsales@access.lk/reprosales@access.lk	Specilized Products / Brands <table border="1"> <tbody> <tr> <td>Photocopi ers</td> <td>Toners</td> <td>-</td> </tr> <tr> <td>-</td> <td>-</td> <td>-</td> </tr> </tbody> </table>	Photocopi ers	Toners	-	-	-	-	Business Reg. No PV11733	RDA Reg No. RDASR 0373
Photocopi ers	Toners	-								
-	-	-								
5	PC Care & Cure (Pvt) Ltd  No.132, King Street, Matale  0662232032/0777385535  0662232032  pccarematale@gmail.com	Specilized Products / Brands <table border="1"> <tbody> <tr> <td>-</td> <td>-</td> <td>-</td> </tr> <tr> <td>-</td> <td>-</td> <td>-</td> </tr> </tbody> </table>	-	-	-	-	-	-	Business Reg. No	RDA Reg No. RDASR 0381
-	-	-								
-	-	-								
6	Lakmuthu IT Solutions  St. Mary's rd, Chilaw  0322221210  -  office@lakmuthu.com	Specilized Products / Brands <table border="1"> <tbody> <tr> <td>Hikvision</td> <td>-</td> <td>-</td> </tr> <tr> <td>-</td> <td>-</td> <td>-</td> </tr> </tbody> </table>	Hikvision	-	-	-	-	-	Business Reg. No	RDA Reg No. RDASR 0403
Hikvision	-	-								
-	-	-								

1.17 Photocopy and Printing Machines

7 John Keells Office Automation (Pvt) Ltd Specilized Products / Brands Business Reg. No

No.90, Union Place, Colombo 02

0112313000
0112431745
jkoa@keells.com

ASUS Desktop	ASUS Laptop	Toshiba Photocopi
viewsonic Multimed	Samsung	

RDA Reg No. **RDASR 0429**

8 Ceylon Business Appliances (Pvt) Ltd Specilized Products / Brands Business Reg. No

No.112, Reid Avenue, Colombo 04

0117845300
0112503121
sales@cba.lk

Densimet ers	-	-
-	-	

RDA Reg No. **RDASR 0451**

9 C.S.Enterprises Specilized Products / Brands Business Reg. No

No.414/1, Godage Mw, Anuradhapura

0718723000/0254580628
0252227147
csenterprises18@gmail.com

ID Card Printer	-	-
-	-	

RDA Reg No. **RDASR 0558**

10 K.N.C.Computer Technologies Pvt ltd Specilized Products / Brands Business Reg. No

No.21 A, Station Rd, Matara

04122342222
0412234222
knccomputer@gmail.com

-	-	-
-	-	

RDA Reg No. **RDASR 0653**

11 Neat Lanka Pvt Ltd Specilized Products / Brands Business Reg. No

No.455/1/A, Galle rd, Colombo 06

0115565000/0777326720/0773979783
0112500704
neatk@slt.lk

-	-	-
-	-	

RDA Reg No. **RDASR 0693**

12 Metropolitan Technologies (Pvt) Ltd Specilized Products / Brands Business Reg. No

























No.12, Magazine rd, Colombo 08

0114700200
0114700267
salesmal@metropolitan.lk













Chigo-Air Condition	ACER-Computer	Printronix-Printers
Power Engineeri	Ninfgoo RDC-PLICATORS	

RDA Reg No. **RDASR 0866**

























1.17 Photocopy and Printing Machines

13	Data Tech Business Centre (Pvt) Ltd	Specilized Products / Brands	Business Reg. No						
	 45A, Dehiwala rd, Pepiliyana  0117631610/11  -  info@datatechlk.com	<table border="1"> <tr> <td>-</td> <td>-</td> <td>-</td> </tr> <tr> <td>-</td> <td>-</td> <td></td> </tr> </table>	-	-	-	-	-		RDA Reg No. RDASR 0730
-	-	-							
-	-								
14	Ewis Peripherals (Pvt) Ltd	Specilized Products / Brands	Business Reg. No						
	 No.142, Yathama Building, Galle rd, Colombo 03  0117496000  0112380580  peripherals@ewisl.net/dineshw@ewisl.net	<table border="1"> <tr> <td>Lexmark</td> <td>Konica minolta</td> <td>pantum</td> </tr> <tr> <td>Octa matrix</td> <td>Riello</td> <td></td> </tr> </table>	Lexmark	Konica minolta	pantum	Octa matrix	Riello		RDA Reg No. RDASR 0762
Lexmark	Konica minolta	pantum							
Octa matrix	Riello								
15	Debug Computer Peripherals (Pvt) Ltd	Specilized Products / Brands	Business Reg. No						
	 No.58, 42nd Lane, Wellawatta, Colombo 06  0117520000  0112362612/0112589597  corporate@debugisp.net/sanjeewaw2debug	<table border="1"> <tr> <td>DCP</td> <td>EPSON</td> <td>KYOCER A</td> </tr> <tr> <td>BENQ</td> <td>SOPHOS</td> <td></td> </tr> </table>	DCP	EPSON	KYOCER A	BENQ	SOPHOS		RDA Reg No. RDASR 0769
DCP	EPSON	KYOCER A							
BENQ	SOPHOS								
16	ICE Technologies (Pvt) Ltd	Specilized Products / Brands	Business Reg. No						
	 Sales Office, No.03, 1st Floor, Bandaranayakapura rd, Rajagiriya  0115231257/0115160260  0112886757  tenders@icetechnologies.lk	<table border="1"> <tr> <td>-</td> <td>-</td> <td>-</td> </tr> <tr> <td>-</td> <td>-</td> <td></td> </tr> </table>	-	-	-	-	-		RDA Reg No. RDASR 0943
-	-	-							
-	-								
17	Softlogic Retail (Pvt) Ltd	Specilized Products / Brands	Business Reg. No						
	 No.402, Level-3, Panasonoc Building, Galle rd, Colombo 03  0115391100  0112375151  kusal@softlogic.lk	<table border="1"> <tr> <td>-</td> <td>-</td> <td>-</td> </tr> <tr> <td>-</td> <td>-</td> <td></td> </tr> </table>	-	-	-	-	-		RDA Reg No. RDASR 0946
-	-	-							
-	-								
18	NSL Distribution (Pvt) Ltd	Specilized Products / Brands	Business Reg. No						
	 No.202/2, 1st Lane, Egodawatta, Boralesgamuwa  0117212129/0713050571  0711004511  info@nsl.lk	<table border="1"> <tr> <td>-</td> <td>-</td> <td>-</td> </tr> <tr> <td>-</td> <td>-</td> <td></td> </tr> </table>	-	-	-	-	-		RDA Reg No. RDASR 0951
-	-	-							
-	-								

1.17 Photocopy and Printing Machines

19	Fintek Managed Solutions (Pvt) Ltd	Specilized Products / Brands	Business Reg. No						
	No.248, Vauxhall Street, Colombo 02	<table border="1"> <tr> <td>SHARP</td> <td>Mis</td> <td>Vivitek</td> </tr> <tr> <td>Posmart</td> <td>Pantum</td> <td></td> </tr> </table>	SHARP	Mis	Vivitek	Posmart	Pantum		
SHARP	Mis	Vivitek							
Posmart	Pantum								
	0117887000								
	0112431172								
	damith@finteksl.com	RDA Reg No.	RDASR 0990						
20	Vanoj Office Automation	Specilized Products / Brands	Business Reg. No						
	561/40,Preeman Mw, Anuradhapura	<table border="1"> <tr> <td>Photo copier</td> <td>Fax machin</td> <td>Laptop</td> </tr> <tr> <td>Computer s</td> <td>Toner, Cartridge</td> <td></td> </tr> </table>	Photo copier	Fax machin	Laptop	Computer s	Toner, Cartridge		
Photo copier	Fax machin	Laptop							
Computer s	Toner, Cartridge								
	0254580054								
	0252226900								
	vanojoffice@gmail.com	RDA Reg No.	RDASR 1014						
21	K.E.Office Automation (Pvt) Ltd	Specilized Products / Brands	Business Reg. No						
	No.369/1/1, Anagarika Dharmapala Mw, Noope, Matara	<table border="1"> <tr> <td>Toshiba Toners</td> <td>Kaspesky</td> <td>Hp</td> </tr> <tr> <td>Samsung</td> <td>Kyocera</td> <td></td> </tr> </table>	Toshiba Toners	Kaspesky	Hp	Samsung	Kyocera		
Toshiba Toners	Kaspesky	Hp							
Samsung	Kyocera								
	0714227427								
	0412234438								
	keofficemataraho@gmail.com	RDA Reg No.	RDASR 1009						

1.18 Photocopy Papers & Thermal Paper Rolls

1	Tillmax Pvt Ltd  No.140/1, Kethsiri Sevana, Thumbowila, Piliyandala  0117355355  .117355350  info@tillmax.lk	Specilized Products / Brands <table border="1"> <tbody> <tr> <td>-</td> <td>-</td> <td>-</td> </tr> <tr> <td>-</td> <td>-</td> <td></td> </tr> </tbody> </table>	-	-	-	-	-		Business Reg. No PV7042 RDA Reg No. RDASR 0039
-	-	-							
-	-								
2	S.B.Printers (Pvt) Ltd  No.441/3, 03rd Kurana, Colombo Rd, Negombo  0312222069  0312228926  sbprinters@sltnet.lk	Specilized Products / Brands <table border="1"> <tbody> <tr> <td>-</td> <td>-</td> <td>-</td> </tr> <tr> <td>-</td> <td>-</td> <td></td> </tr> </tbody> </table>	-	-	-	-	-		Business Reg. No PV6485 RDA Reg No. RDASR 0075
-	-	-							
-	-								
3	Lanka Paper Products (Pvt) Ltd  No.110/3, Thunandahena rd, Off Kahanthota rd,Pittugala, Malabe  0112407534  0114444436  lankapaper@sltnet.lk	Specilized Products / Brands <table border="1"> <tbody> <tr> <td>Mitsubishi</td> <td>OJI</td> <td>-</td> </tr> <tr> <td>-</td> <td>-</td> <td></td> </tr> </tbody> </table>	Mitsubishi	OJI	-	-	-		Business Reg. No PV13423 RDA Reg No. RDASR 0106
Mitsubishi	OJI	-							
-	-								
4	Lakwin Enterprises  No.53, Prince Street, Colombo 11  01125425555/2542556/2424734  0112424733  lakwinent@sltnet.com	Specilized Products / Brands <table border="1"> <tbody> <tr> <td>-</td> <td>-</td> <td>-</td> </tr> <tr> <td>-</td> <td>-</td> <td></td> </tr> </tbody> </table>	-	-	-	-	-		Business Reg. No W/A 11414 RDA Reg No. RDASR 0110
-	-	-							
-	-								
5	Imtiaz Packirdeen  No.5, Lower Street, Badulla  0552222497  0552223442  imtiazcad@gmail.com	Specilized Products / Brands <table border="1"> <tbody> <tr> <td>-</td> <td>-</td> <td>-</td> </tr> <tr> <td>-</td> <td>-</td> <td></td> </tr> </tbody> </table>	-	-	-	-	-		Business Reg. No RDA Reg No. RDASR 0405
-	-	-							
-	-								
6	Nissico Holding  No.50, Maliban Street, Colombo 11  01123336885/2333141/0777891820  0112333847  nissico@slt.lk	Specilized Products / Brands <table border="1"> <tbody> <tr> <td>-</td> <td>-</td> <td>-</td> </tr> <tr> <td>-</td> <td>-</td> <td></td> </tr> </tbody> </table>	-	-	-	-	-		Business Reg. No RDA Reg No. RDASR 0430
-	-	-							
-	-								

1.18 Photocopy Papers & Thermal Paper Rolls

7 **T.D.R.Engineering and Construction** Specilized Products / Brands Business Reg. No

No.08, Good Shed Rd, Rathnapura

0717850600

0452222118

tdengineeringc@gmail.com

-	-	-
-	-	

RDA Reg No. RDASR 0817

8 **Metropolitan Technologies (Pvt) Ltd** Specilized Products / Brands Business Reg. No

No.12, Magazine rd, Colombo 08

0114700200

0114700267

salesmal@metropolitan.lk

Chigo-Air Condition Power Engineeri	Acer- Computer Ningbo RDC-	Printronix- Printers
--	-------------------------------------	-------------------------

RDA Reg No. RDASR 0866

9 **Fakhri Trading Company** Specilized Products / Brands Business Reg. No

No.252, Dam Street, Colombo 12

0112320644

0012470622

sales@fakhritrading.lk

Atlas	Panther	Promate
Pieris	Nalaka	

RDA Reg No. RDASR 0898

10 **AP Enterprises (Pvt) Ltd** Specilized Products / Brands Business Reg. No

No.39, Maliban street, Colombo 11

0117933833/0117933804

0112439094

ranjeewa@apenterprises.lk

Avalon	IT Signature	PPC Brown
IK Copy	-	

RDA Reg No. RDASR 0909

11 **Packsco Ceylon (Pvt) Ltd** Specilized Products / Brands Business Reg. No

No.19, St. Michal's rd, Colombo 03

0112343100-1

0112343103

info@packsco.lk

-	-	-
-	-	

RDA Reg No. RDASR 0942

12 **Narah Computer Foems** Specilized Products / Brands Business Reg. No

309/4C, Negombo rd, Welisara

0112245700-888













0112245900/0112230061

narahncf@gmail.com

-	-	-
-	-	

RDA Reg No. RDASR 0950

1.19 Plants/ Fertilizers

1	Green Lanka	Specilized Products / Brands	Business Reg. No. WJ18171			
	 No.401/1, 10th mile Post Rd, Werahera, Boralesgamuwa	<table border="1"> <tr> <td>-</td> <td>-</td> <td>-</td> </tr> </table>	-	-	-	
-	-	-				
	 0761028366/0761028367	<table border="1"> <tr> <td>-</td> <td>-</td> <td></td> </tr> </table>	-	-		
-	-					
	 0117571997					
	 greenlankan@gmail.com	RDA Reg No. RDASR 0036				
2	T.D.R.Engineering and Construction	Specilized Products / Brands	Business Reg. No. 3917			
	 No.08, Good Shed Rd, Rathnapura	<table border="1"> <tr> <td>-</td> <td>-</td> <td>-</td> </tr> </table>	-	-	-	
-	-	-				
	 0717850600	<table border="1"> <tr> <td>-</td> <td>-</td> <td></td> </tr> </table>	-	-		
-	-					
	 0452222118					
	 tdengineeringc@gmail.com	RDA Reg No. RDASR 0817				
3	B.M.D.K.Bandaranayake	Specilized Products / Brands	Business Reg. No. CP/UKU/PC/2 101			
	 230/10, Kendagolla, Mathale	<table border="1"> <tr> <td>-</td> <td>-</td> <td>-</td> </tr> </table>	-	-	-	
-	-	-				
	 0662225315/0717582019	<table border="1"> <tr> <td>-</td> <td>-</td> <td></td> </tr> </table>	-	-		
-	-					
	 -					
	 dilshabandaranayake29@gmail.com	RDA Reg No. RDASR 0979				

1.20 Spare Parts (Construction Equipment & Machinery)

1	Matrix (Private) Ltd	Specilized Products / Brands	Business Reg. No	PV648
	No.850, Bulugaja Junction, Kandy rd, Dalugama, Kelaniya	-	-	-
	0114377313	-	-	-
	0112912487			
	matrix@slt.lk / matrix@matrix.com	RDA Reg No.	RDASR	0009
2	Gamini Traders Y.A.P.(Pvt) Ltd	Specilized Products / Brands	Business Reg. No	PV00210107
	No.39/A, Avissawella Rd, Ranala	-	-	-
	0114294005	-	-	-
	0117460773			
	heshantraders@gaminigroup.lk	RDA Reg No.	RDASR	0087
3	Lanka Construction & Marketing (Pvt) Ltd	Specilized Products / Brands	Business Reg. No	PV1280
	235, Kandewatta Rd, Thalangama South, Battaramulla	-	-	-
	0777066801/0112785177	-	-	-
	0112785270			
	lamget@lamlanka.lk	RDA Reg No.	RDASR	0192
4	Senok Trade Combine (Pvt) Ltd	Specilized Products / Brands	Business Reg. No	PV7246
	No.175, Grandpass Rd, Colombo 14	1.20 Spare Parts - Construction	-	-
	0112472798	-	-	-
	0112472801			
	shashi@senoksl.com	RDA Reg No.	RDASR	0256
5	Diesel & Motor Engineering PLC	Specilized Products / Brands	Business Reg. No	
	No.65, Jethamana Rd, Colombo 14	-	-	-
	0112449797/0112338883	-	-	-
	0112449080			
	dimo@dimolanka.com	RDA Reg No.	RDASR	0476
6	Ontarc (Pvt) Ltd	Specilized Products / Brands	Business Reg. No	
	137, Mahena Rd, Siyambalape	-	-	-
	0114740954	-	-	-
	0114740954			
	ontarc@sltnet.lk	RDA Reg No.	RDASR	0489

7 **Analytical Instruments (Pvt) Ltd**

 No.100, Elvitigala Mw, Colombo 08

 0112639000

 0112699282

 analytical@aipi.lk

Specilized Products / Brands

Business
Reg. No

-	-	-
-	-	

RDA Reg No. RDASR **0490**

8 **K.C.Heavy Equipment Spares Co. (Pvt) Ltd**

 No.85/1, Sirimavo Bandaranayake Mw, Colombo 14

 0112434098/0112330454

 0112330455

 k.c.heavy@hotmail.com

Specilized Products / Brands

Business
Reg. No

-	-	-
-	-	

RDA Reg No. RDASR **0497**

9 **Trident Holdings (Pvt) Ltd**

 No.63/1, Maharagama rd, Boralesgamuwa

 0112715657

 0112150806

 info@tridentholdings.lk

Specilized Products / Brands

Business
Reg. No

Boreholdri lling	Survey Equipmen	Core Drilling
0	-	

RDA Reg No. RDASR **0733**

10 **United Tractor & Equipment (Pvt) Ltd**

 No.683, Negombo Rd, Wattala, Mabile

 0773457320/0114828267

 0112931550/0112935573

 sales@ute.lk/ranjana@ute.lk

Specilized Products / Brands

Business
Reg. No

Caterpillar SARL	ESAB India Ltd	AJAX Engineering Pvt Ltd
-	-	

RDA Reg No. RDASR **0882**

1.21 Spare Parts

(Electric Equipment)

1 #N/A

Specilized Products / Brands

Business Reg. No #N/A

 #N/A

#N/A	#N/A	#N/A
------	------	------

 #N/A

#N/A	#N/A
------	------

 #N/A

 #N/A

RDA Reg No.

RDASR	-
-------	---

1.22 Spare Parts (Motor Cycle)

1 Lazar J (Pvt) Ltd



No.20, Dematagoda Place, Colombo 9



0741639978



-



lazarjems@gmail.com

Specilized Products / Brands

-	-	-
-	-	-

Business
Reg. No

PV00231550

RDA Reg No.

RDASR

0438

2

Joe Brothers



No.09, Jayamaha Vihara Rd, Thotamuna,
Matara



0412235554/0714336510



-



goebrotherspls@gmail.com

Specilized Products / Brands

-	-	-
-	-	-

Business
Reg. No

Ma/1/929

RDA Reg No.

RDASR

0667

1.23 Spare Parts (Motor Launches including Marine Engines & Out Board)

1 **Lazar J (Pvt) Ltd**

Specilized Products / Brands

Business
Reg. No PV00231550



No.20, Dematagoda Place, Colombo 9

-	-	-
-	-	



0741639978



-



























lazarjems@gmail.com

























RDA Reg No.

RDASR 0438

























1.24 Spare Parts (Motor Vehicle)

1	Colonial Motors (Ceylon) Ltd  No.449, Negombo rd, Peliyagoda  0117699555  0117449450  info@mazdalanka.lk	Specilized Products / Brands <table border="1"> <tr> <td>-</td> <td>-</td> <td>-</td> </tr> <tr> <td>-</td> <td>-</td> <td></td> </tr> </table>	-	-	-	-	-		Business Reg. No PB1086 RDA Reg No. RDASR 0020
-	-	-							
-	-								
2	D.M.Auto Spare Spares (Pvt) Ltd  No.334/108, Main Street, Anuradhapura  0252223622  -  dmqutospare@gmail.com	Specilized Products / Brands <table border="1"> <tr> <td>-</td> <td>-</td> <td>-</td> </tr> <tr> <td>-</td> <td>-</td> <td></td> </tr> </table>	-	-	-	-	-		Business Reg. No PV9356 RDA Reg No. RDASR 0023
-	-	-							
-	-								
3	Colonial Motors (Ceylon) Ltd  No.449, Negombo rd, Peliyagoda  0117699555  0117449450  info@mazdalanka.lk	Specilized Products / Brands <table border="1"> <tr> <td>-</td> <td>-</td> <td>-</td> </tr> <tr> <td>-</td> <td>-</td> <td></td> </tr> </table>	-	-	-	-	-		Business Reg. No PB1086 RDA Reg No. RDASR 0020
-	-	-							
-	-								
4	Toyotsu Lanka (Pvt) Ltd  No.359, Negombo rd, Wattala  0112904949  0112904945  info@toyotsu.lk	Specilized Products / Brands <table border="1"> <tr> <td>-</td> <td>-</td> <td>-</td> </tr> <tr> <td>-</td> <td>-</td> <td></td> </tr> </table>	-	-	-	-	-		Business Reg. No PV00225489 RDA Reg No. RDASR 0227
-	-	-							
-	-								
5	Semini Motors (Pvt) Ltd  No.632/2, Welikadamulla Rd, Mabola, wattala  0112936928  0112937736  dinel@seminimotors.com	Specilized Products / Brands <table border="1"> <tr> <td>-</td> <td>-</td> <td>-</td> </tr> <tr> <td>-</td> <td>-</td> <td></td> </tr> </table>	-	-	-	-	-		Business Reg. No RDA Reg No. RDASR 0228
-	-	-							
-	-								
6	Lazar J (Pvt) Ltd  No.20, Dematagoda Place, Colombo 9  0741639978  -  lazarjems@gmail.com	Specilized Products / Brands <table border="1"> <tr> <td>-</td> <td>-</td> <td>-</td> </tr> <tr> <td>-</td> <td>-</td> <td></td> </tr> </table>	-	-	-	-	-		Business Reg. No RDA Reg No. RDASR 0438
-	-	-							
-	-								

1.24 Spare Parts (Motor Vehicle)

7	Diesel & Motor Engineering PLC	Specilized Products / Brands	Business Reg. No						
	No.65, Jethamana Rd, Colombo 14	<table border="1"><tr><td>-</td><td>-</td><td>-</td></tr><tr><td>-</td><td>-</td><td></td></tr></table>	-	-	-	-	-		
-	-	-							
-	-								
	0112449797/0112338883								
	0112449080								
	dimo@dimolanka.com	RDA Reg No.	RDASR 0476						
8	K.C.Heavy Equipment Spares Co. (Pvt) Ltd	Specilized Products / Brands	Business Reg. No						
	No.85/1, Sirimavo Bandaranayake Mw, Colombo 14	<table border="1"><tr><td>-</td><td>-</td><td>-</td></tr><tr><td>-</td><td>-</td><td></td></tr></table>	-	-	-	-	-		
-	-	-							
-	-								
	0112434098/0112330454								
	0112330455								
	k.c.heavy@hotmail.com	RDA Reg No.	RDASR 0497						
9	Brown & Company PLC	Specilized Products / Brands	Business Reg. No						
	No.34, Sir Mohamed Macan Markar Mw, Colombo 03	<table border="1"><tr><td>-</td><td>-</td><td>-</td></tr><tr><td>-</td><td>-</td><td></td></tr></table>	-	-	-	-	-		
-	-	-							
-	-								
	0115063280								
	0112307377								
	procurement@brownsgroup.com	RDA Reg No.	RDASR 0736						
10	Vindeev Auto (Pvt) Ltd	Specilized Products / Brands	Business Reg. No						
	Highlaval rd, Kottawa, Pannipitiya	<table border="1"><tr><td>-</td><td>-</td><td>-</td></tr><tr><td>-</td><td>-</td><td></td></tr></table>	-	-	-	-	-		
-	-	-							
-	-								
	0113031710/0773172734								
	0112838875								
	vindeevauto@yahoo.com	RDA Reg No.	RDASR 0917						
11	Vikasitha Enterprises (Pvt) Ltd	Specilized Products / Brands	Business Reg. No						
	No.225, High Level rd, Galawilawatta, Homagama	<table border="1"><tr><td>-</td><td>-</td><td>-</td></tr><tr><td>-</td><td>-</td><td></td></tr></table>	-	-	-	-	-		
-	-	-							
-	-								
	0772518657								
	0112748429								
	sales.vikasitha@gmail.com	RDA Reg No.	RDASR 0988						
12	Dahanayake Motors (Pvt) Ltd	Specilized Products / Brands	Business Reg. No						
	147/A, Panchikawatte rd, Colombo 10	<table border="1"><tr><td>-</td><td>-</td><td>-</td></tr><tr><td>-</td><td>-</td><td></td></tr></table>	-	-	-	-	-		
-	-	-							
-	-								
	0112386686								
	0112431435								
	dahamoto@sltnet.lk	RDA Reg No.	RDASR 1000						

1.25 Spare Parts Used & Serviceable Spares Parts for Vehicles and Machine

1	Gamini Traders Y.A.P.(Pvt) Ltd	Specilized Products / Brands	Business Reg. No	PV0021010 7						
	 No.39/A, Avissawella Rd, Ranala	<table border="1"><tr><td>-</td><td>-</td><td>-</td></tr><tr><td>-</td><td>-</td><td>-</td></tr></table>	-	-	-	-	-	-		
-	-	-								
-	-	-								
	 0114294005									
	 0117460773									
	 heshantraders@gaminigroup.lk		RDA Reg No.	RDASR 0087						
2	Lanka Construction & Marketing (Pvt) Ltd	Specilized Products / Brands	Business Reg. No	PV1280						
	 235, Kandewatta Rd, Thalangama South, Battaramulla	<table border="1"><tr><td>-</td><td>-</td><td>-</td></tr><tr><td>-</td><td>-</td><td>-</td></tr></table>	-	-	-	-	-	-		
-	-	-								
-	-	-								
	 0777066801/0112785177									
	 0112785270									
	 lamget@lamlanka.lk		RDA Reg No.	RDASR 0192						
3	Lazar J (Pvt) Ltd	Specilized Products / Brands	Business Reg. No	PV0023155 0						
	 No.20, Dematagoda Place, Colombo 9	<table border="1"><tr><td>-</td><td>-</td><td>-</td></tr><tr><td>-</td><td>-</td><td>-</td></tr></table>	-	-	-	-	-	-		
-	-	-								
-	-	-								
	 0741639978									
	 -									
	 lazarjems@gmail.com		RDA Reg No.	RDASR 0438						
4	Diesel & Motor Engineering PLC	Specilized Products / Brands	Business Reg. No	PQ146						
	 No.65, Jethamana Rd, Colombo 14	<table border="1"><tr><td>-</td><td>-</td><td>-</td></tr><tr><td>-</td><td>-</td><td>-</td></tr></table>	-	-	-	-	-	-		
-	-	-								
-	-	-								
	 0112449797/0112338883									
	 0112449080									
	 dimo@dimolanka.com		RDA Reg No.	RDASR 0476						
5	Diesel & Motor Engineering PLC	Specilized Products / Brands	Business Reg. No							
	 No.65, Jethamana Rd, Colombo 14	<table border="1"><tr><td>-</td><td>-</td><td>-</td></tr><tr><td>-</td><td>-</td><td>-</td></tr></table>	-	-	-	-	-	-		
-	-	-								
-	-	-								
	 0112449797/0112338883									
	 0112449080									
	 dimo@dimolanka.com		RDA Reg No.	RDASR 0476						
6	Brown & Company PLC	Specilized Products / Brands	Business Reg. No							
	 No.34, Sir Mohamed Macan Markar Mw, Colombo 03	<table border="1"><tr><td>-</td><td>-</td><td>-</td></tr><tr><td>-</td><td>-</td><td>-</td></tr></table>	-	-	-	-	-	-		
-	-	-								
-	-	-								
	 0115063280									
	 0112307377									
	 procurement@brownsgroup.com		RDA Reg No.	RDASR 0736						

1.25 Spare Parts Used & Serviceable Spares Parts for Vehicles and Machine

7 **United Tractor & Equipment (Pvt) Ltd** Specilized Products / Brands

Business
Reg. No



No.683, Negombo Rd, Wattala, Mabile

Caterpillar SARL	ESAB India Ltd	ASJA Engineeri ng Pvt Ltd
-	-	



0773457320/0114828267



0112931550/0112935573



sales@ute.lk/ranjana@ute.lk

RDA Reg No.

RDASR

0882

1.26 Surveying and Leveling Equipments

1	Suleco (Pvt) Ltd	Specilized Products / Brands	Business Reg. No	PV70495						
	No.44, Beddagana South, Pitakotte	<table border="1"> <tr> <td>Laboratory Equipment</td> <td>Survey Equipment</td> <td>-</td> </tr> <tr> <td>-</td> <td>-</td> <td></td> </tr> </table>	Laboratory Equipment	Survey Equipment	-	-	-			
Laboratory Equipment	Survey Equipment	-								
-	-									
	0112828100									
	0112828100									
	tendering@suleco.lk		RDA Reg No.	RDASR 0100						
2	Scientific Business Systems (Pvt) Ltd	Specilized Products / Brands	Business Reg. No	PV8312/N(PVS01745)						
	No.30, Albert Crescent, 1st Floor, Nanda Motors Building, Colombo 7	<table border="1"> <tr> <td>TOPCON BRAND</td> <td>-</td> <td>-</td> </tr> <tr> <td>-</td> <td>-</td> <td></td> </tr> </table>	TOPCON BRAND	-	-	-	-			
TOPCON BRAND	-	-								
-	-									
	0112686857/0112686870									
	0112699179									
	sales@sbs.lk/survey@sbs.lk		RDA Reg No.	RDASR 0303						
3	Ontarc (Pvt) Ltd	Specilized Products / Brands	Business Reg. No	PV372						
	137, Mahena Rd, Siyambalape	<table border="1"> <tr> <td>-</td> <td>-</td> <td>-</td> </tr> <tr> <td>-</td> <td>-</td> <td></td> </tr> </table>	-	-	-	-	-			
-	-	-								
-	-									
	0114740954									
	0114740954									
	ontarc@sltnet.lk		RDA Reg No.	RDASR 0489						
4	Analytical Instruments (Pvt) Ltd	Specilized Products / Brands	Business Reg. No	PV1328						
	No.100, Elvitigala Mw, Colombo 08	<table border="1"> <tr> <td>-</td> <td>-</td> <td>-</td> </tr> <tr> <td>-</td> <td>-</td> <td></td> </tr> </table>	-	-	-	-	-			
-	-	-								
-	-									
	0112639000									
	0112699282									
	analytical@aipl.lk		RDA Reg No.	RDASR 0490						
5	Research Instruments Pvt Ltd	Specilized Products / Brands	Business Reg. No							
	No.140 2/1, P.O.Box: 45, Galle Rd, Mount Lavinia	<table border="1"> <tr> <td>Total Stations</td> <td>Theodolite Etc.</td> <td>Laboratory</td> </tr> <tr> <td>Glassware</td> <td>Chemicals</td> <td></td> </tr> </table>	Total Stations	Theodolite Etc.	Laboratory	Glassware	Chemicals			
Total Stations	Theodolite Etc.	Laboratory								
Glassware	Chemicals									
	0115708001									
	0115708002									
	info@researchinstruments.lk		RDA Reg No.	RDASR 0609						
6	R.N.Construction and Survey Consultant	Specilized Products / Brands	Business Reg. No							
	No.120/2, Rassagala rd, Balangoda	<table border="1"> <tr> <td>-</td> <td>-</td> <td>-</td> </tr> <tr> <td>-</td> <td>-</td> <td></td> </tr> </table>	-	-	-	-	-			
-	-	-								
-	-									
	0776178919									
	-									
	pradeepindunnil45@gmail.com/pradeepindun		RDA Reg No.	RDASR 0782						

7 **Instech (Pvt) Ltd**

72/1, , Carlton Residencies, Pepiliyana rd, Nedimala

0117922665

0117922665

instech.trade@gmail.com

Specilized Products / Brands

Business Reg. No

Survey Equipment	GPS	Asphalt Testing
Soil Testing Equipments	Contrete Testing Equipments	

RDA Reg No. RDASR 0960

8 **Bhoomi Tech (Pvt) Ltd**

No.184, Hill Street, Dehiwala

0112734550/0112734551

0112713088

labsales@bhoomitech.com

Specilized Products / Brands

Business Reg. No

Soil Testing	Concrete Testing	Asphalt Testing
Bitumen Testing	Non-Destructiv	

RDA Reg No. RDASR 0961

9 **Glabal GIS (Pvt) Ltd**

No.58, Pagoda rd, Nugegoda

0112824877/0113024377

-

solution.globalgis@gmail.com/info@globalgis

Specilized Products / Brands

Business Reg. No

Pentax	Kolida	e-Survey
NAVA	Geomax	

RDA Reg No. RDASR 0965

10 **Sumathi Information Technologies (Pvt) Ltd**

No.491, Galle rd, Colombo 03

0773887013/0115553311

0115553312

info@sit.lk

Specilized Products / Brands

Business Reg. No

Pix4D	TRD	Rafael Advanced
-	-	

RDA Reg No. RDASR 1035

1.27 Sweeper Brushes

1 **T.D.R.Engineering and Construction** Specilized Products / Brands Business Reg. No 3917



No.08, Good Shed Rd, Rathnapura

-	-	-
-	-	



0717850600



0452222118















tdengineeringc@gmail.com

























RDA Reg No.

RDASR 0817

1.28 Tracing & Plotter Papers

1	papyrus Papers (Pvt) Ltd	Specilized Products / Brands	Business Reg. No	PV5232						
	277, Vauxhall Street, Colombo 02	<table border="1"><tr><td>-</td><td>-</td><td>-</td></tr><tr><td>-</td><td>-</td><td></td></tr></table>	-	-	-	-	-			
-	-	-								
-	-									
	0112314027									
	0112314028									
	info@papyrus.lk		RDA Reg No.	RDASR 0015						
2	Metropolitan Technologies (Pvt) Ltd	Specilized Products / Brands	Business Reg. No	Pr9395						
	No.12, Magazine rd, Colombo 08	<table border="1"><tr><td>Chigo-Air Conditioner</td><td>ACER Computer</td><td>Printronix- Printers</td></tr><tr><td>Power Engineeri</td><td>Ningbo RDC-</td><td></td></tr></table>	Chigo-Air Conditioner	ACER Computer	Printronix- Printers	Power Engineeri	Ningbo RDC-			
Chigo-Air Conditioner	ACER Computer	Printronix- Printers								
Power Engineeri	Ningbo RDC-									
	0114700200									
	0114700267									
	salesmal@metropolitan.lk		RDA Reg No.	RDASR 0866						
2	ICE Technologies (Pvt) Ltd	Specilized Products / Brands	Business Reg. No	PV77757						
	Sales Office, No.03, 1st Floor, Bandaranayakapura rd, Rajagiriya	<table border="1"><tr><td>-</td><td>-</td><td>-</td></tr><tr><td>-</td><td>-</td><td></td></tr></table>	-	-	-	-	-			
-	-	-								
-	-									
	0115231257/0115160260									
	0112886757									
	tenders@icetechnologies.lk		RDA Reg No.	RDASR 0943						

1.29 Tyres, Tubes, Flaps and Batteries for Vehicle and Machinery

1	Chandimal Tyre Mart	Specilized Products / Brands	Business Reg. No	2014.05.06						
	 "Sethmi", Saummerfield Mw; Kahawatta, Beliatta	<table border="1"><tr><td>-</td><td>-</td><td>-</td></tr><tr><td>-</td><td>-</td><td></td></tr></table>	-	-	-	-	-			
-	-	-								
-	-									
	 0472251599									
	 -									
	 raminheupul@gmail.com		RDA Reg No.	RDASR 0001						
2	Matrix (Private) Ltd	Specilized Products / Brands	Business Reg. No	PV648						
	 No.850, Bulugaja Junction, Kandy rd, Dalugama, Kelaniya	<table border="1"><tr><td>-</td><td>-</td><td>-</td></tr><tr><td>-</td><td>-</td><td></td></tr></table>	-	-	-	-	-			
-	-	-								
-	-									
	 0114377313									
	 0112912487									
	 matrix@slt.lk / matrix@matrix.com		RDA Reg No.	RDASR 0009						
3	Ajith Tyre Traders	Specilized Products / Brands	Business Reg. No	WA1288						
	 194, Sri sangaraja Mw, Colombo 10	<table border="1"><tr><td>-</td><td>-</td><td>-</td></tr><tr><td>-</td><td>-</td><td></td></tr></table>	-	-	-	-	-			
-	-	-								
-	-									
	 0112331592									
	 0112331593									
	 ajithtyre@gmail.com		RDA Reg No.	RDASR 0048						
4	Jayantha Traders	Specilized Products / Brands	Business Reg. No	W/15591						
	 No.408, Kandy Rd, Kelaniya	<table border="1"><tr><td>-</td><td>-</td><td>-</td></tr><tr><td>-</td><td>-</td><td></td></tr></table>	-	-	-	-	-			
-	-	-								
-	-									
	 0112987614/0112914883									
	 0112914873									
	 jyanthatyres@gmail.com		RDA Reg No.	RDASR 0050						
5	Mahanuwara Tyre Centre (Pvt) Ltd	Specilized Products / Brands	Business Reg. No							
	 No.2052/1,2,3, Wijesekararama Mw, Marcket Place, Anuradhapura	<table border="1"><tr><td>-</td><td>-</td><td>-</td></tr><tr><td>-</td><td>-</td><td></td></tr></table>	-	-	-	-	-			
-	-	-								
-	-									
	 0252222827/0702515164									
	 0252220833									
	 mahanuwaratyrecentre@gmail.com		RDA Reg No.	RDASR 0052						
6	ATM Tyre Mart	Specilized Products / Brands	Business Reg. No							
	 No.551/1, Kotte Rd, Pitakotte	<table border="1"><tr><td>-</td><td>-</td><td>-</td></tr><tr><td>-</td><td>-</td><td></td></tr></table>	-	-	-	-	-			
-	-	-								
-	-									
	 0718713935									
	 0112078051									
	 atm.tyremart@yahoo.com		RDA Reg No.	RDASR 0054						

1.29 Tyres, Tubes, Flaps and Batteries for Vehicle and Machinery

7 CJ Holdings

 6M, 22, Siriperakumba Piriwena Mw, Ethulkotte

 0112886436

 0112886436

 c_jholdings@yahoo.com

Specilized Products / Brands

Business Reg. No

-	-	-
-	-	

RDA Reg No. RDASR **0060**

8 Suncom Networks (Pvt) Ltd

 28, Dampitiyawa Rd, Padukka

 0112184760

 -

 suncom@sltnet.lk

Specilized Products / Brands

Business Reg. No

-	-	-
-	-	

RDA Reg No. RDASR **0063**

9 Macom Strategic Solutions (Pvt) Ltd

 No.26, Kotte Rd, Ethulkotte

 0777870903

 0112886588

 tyres.macom@gmail.com

Specilized Products / Brands

Business Reg. No

-	-	-
-	-	

RDA Reg No. RDASR **0064**

10 Crown Tyres (Pvt) Ltd

 155, Sirimavo Bandaranayake Mw, Colombo 14

 0112449558/0112344524

 0112334116

 info.crowntyres@gmail.com

Specilized Products / Brands

Business Reg. No

-	-	-
-	-	

RDA Reg No. RDASR **0076**

11 Sandiw Auto Enterprise (Pvt) Ltd

 No.55, Prince of Wales Avenue, Colombo - 14

 0114379166

 0112431996

 sandeewauto@gmail.com

Specilized Products / Brands

Business Reg. No

-	-	-
-	-	

RDA Reg No. RDASR **0079**

12 S.K.Munasinghe Motors

 No.436, Hawlock Rd, Colombo 6

 0112589432/0112590313

 0112502258

 kodagoda@-skmmgroup.com

Specilized Products / Brands

Business Reg. No

Dunlop Tyres	-	-
-	-	

RDA Reg No. RDASR **0132**

1.29 Tyres, Tubes, Flaps and Batteries for Vehicle and Machinery

13 Swarnakelum Group (Pvt) Ltd

 No.81, Papiliyana Rd, Gangodawila, Nugegoda

 0112810716

 0112813090

 sup@swarnakelum.com

Specilized Products / Brands

-	-	-
-	-	

Business Reg. No

RDA Reg No. RDASR **0135**

14 Accmart Motors (Pvt) Ltd

 No.14,Sri Perakum Mw, Kotte Rd, Kotte

 0112888941-943

 0112888945

 accmart_tyres@sltnet.lk

Specilized Products / Brands

Bridgesto ne	Dunlop	Yokoham a
Pirelli	Michelin	

Business Reg. No

RDA Reg No. RDASR **0176**

15 Suhada Tyre Traders

 No.18/A, Main Street,Battaramulla

 0773927856/0776416669

 -

 suhadatyre7@gmail.com

Specilized Products / Brands

-	-	-
-	-	

Business Reg. No

RDA Reg No. RDASR **0200**

16 M.J.R.Peries and Sons (Pvt) Ltd

 No194, Katugastota Rd, Kandy

 0812234373

 0812228602

 infomjroeirisandsons.com

Specilized Products / Brands

-	-	-
-	-	

Business Reg. No

RDA Reg No. RDASR **0208**

17 Danula Tyre works (Pvt) Ltd

 725/2, Kaduwela Rd, Thalahena, Battaramulla

 0112790515

 0112790270

 lakmalow@gmail.com

Specilized Products / Brands

Tyre Tube	Battery	-
-	-	

Business Reg. No

RDA Reg No. RDASR **0271**

18 Golden Wing Lanka International (Pvt) Ltd

 No.151, Highlevel rd, Pannipitiya

 0112838384/0777399835

 0112838384

 dckgayan@gmail.com

Specilized Products / Brands

-	-	-
-	-	

Business Reg. No

RDA Reg No. RDASR **0283**

1.29 Tyres, Tubes, Flaps and Batteries for Vehicle and Machinery

19 Dharmasiri Tyre House (Pvt) Ltd



No.35/7, Shop Place, Kaduruwela



0272223388/0716844179



0272227777



dthtyres@slt.lk/dthsuganth@gmail.com

Specilized Products / Brands

DTH SUPER DAG Tyre	DTHHIGH RUN Tyre	DTH FLAPS
NANDI Tubes	BKT Tyre	

Business Reg.
No

RDA Reg No.

RDASR

0353

20 Wheels (Pvt) Ltd



No.209, Union Place, Colombo 02



0117770500 Ext 220



0112300877



wheelsssudharajay@gmail.com

Specilized Products / Brands

NANKAN G	A.PLUS	ROYAL BLACK
WSTLAK E	VIKRANT	

Business Reg.
No

RDA Reg No.

RDASR

0359

21 Dulanka International (Pvt) Ltd



ST George Estate, Yatadola, Mathugama



0382241216/0772352677



0382245100



dulankainternational@gmail.com

Specilized Products / Brands

-	-	-
-	-	

Business Reg.
No

RDA Reg No.

RDASR

0445

22 Benedictsons (Pvt) Ltd



No.221 1/2, Sri Sangaraja Mw, Colombo 10



0115445400



0115445415



thsthkumara@yahoo.com

Specilized Products / Brands

Tyres & Tubes	-	-
-	-	

Business Reg.
No

RDA Reg No.

RDASR

0452

23 Tyre House Trading (Pvt) Ltd



No.221 1/4, Sri Sangaraja Mw, Colombo 10



0115445400



0112441693



thsth.kumara@yahoo.com

Specilized Products / Brands

Tyres & Tubes	-	-
-	-	

Business Reg.
No

RDA Reg No.

RDASR

0453

24 Diesel & Motor Engineering PLC



No.65, Jethamana Rd, Colombo 14



0112449797/0112338883



0112449080



dimo@dimolanka.com

Specilized Products / Brands

-	-	-
-	-	

Business Reg.
No

RDA Reg No.

RDASR

0476

1.29 Tyres, Tubes, Flaps and Batteries for Vehicle and Machinery

25 USP Tyre & Auto Center (Pvt) Ltd

No.207, Piliyandala rd, Pepiliyana, Boraesgamuwa

0114347817/8

0112099745

usptyre@gmail.com

Specilized Products / Brands

Dunlop Tyres	Ceat	Federal
Bridgestone	Nankong	

Business Reg. No

RDA Reg No. RDASR 0524

26 Serendib Tyre & Battery City

No.551, New kalmunai rd, Manchanthoduwai, Batticaloa

0652247291

-

serendibkky@gmail.com

Specilized Products / Brands

Tyres & Tubes	Batteries	Tubesand Flaps
-	-	

Business Reg. No

RDA Reg No. RDASR 0572

27 K.D.K. Tyre Service

Near the Clock Tower, Athura, Bulathsinhala

0776067734

-

kdktyre@gmail.com

Specilized Products / Brands

-	-	-
-	-	

Business Reg. No

RDA Reg No. RDASR 0819

28 Trident Holdings (Pvt) Ltd

No.63/1, Maharagama rd, Boraesgamuwa

0112715657

0112150806

info@tridentholdings.lk

Specilized Products / Brands

Borehole Drilling Machine	Survey Equipments	Core Drilling Accessori
0	-	

Business Reg. No

RDA Reg No. RDASR 0733

29 Brown & Company PLC

No.34, Sir Mohamed Macan Markar Mw, Colombo 03

0115063280

0112307377

procurement@brownsgroup.com

Specilized Products / Brands

-	-	-
-	-	

Business Reg. No

RDA Reg No. RDASR 0736

30 S/L State Trading (General) Corporation Ltd

No.100, Nawam Mw, Colombo 02

0112422342/4

0112447970

lankagen@sltnet.lk

Specilized Products / Brands

Nano mask	STC Mask	STC Sanitizers
-	-	

Business Reg. No

RDA Reg No. RDASR 0881

1.29 Tyres, Tubes, Flaps and Batteries for Vehicle and Machinery

31 State Trading (General) Corporation Specilized Products / Brands Business Reg. No

No.449, Wlliom Gopallawa Mw, Kandy

0812200030/50,0702590312

0812200066

stckandy@slt.lk/channastc@gmail.com

-	-	-
-	-	

RDA Reg No. RDASR **0767**

32 Universal Tyres (Pvt) Ltd Specilized Products / Brands Business Reg. No

No.1043 1/1, Maradana rd, Borella, Colombo 08

0112693566/0112678533/0761393114

0112677463

dushan.universal@gmail.com

Lassa(Europe)	Bridgestone	Goodyear
Yokohama	GT Radials	

RDA Reg No. RDASR **0923**

33 Sethmini Trading Company (Pvt) Ltd Specilized Products / Brands Business Reg. No

No.110G, New Kandy rd, Kothalawala, Kaduwela

0777743864

-

ruwanpathirana19872@icloud.com

Hankook	Sailun	Good Year
Maxxis	Accelera	

RDA Reg No. RDASR **0933**

34 Super Enterprises Specilized Products / Brands Business Reg. No

183/2, Horana rd, Kesbewa

0777427943/0112703132

0112703132

ctwchamila@gmail.com

GT Radial Tyres	Maxxis Tyres	Ferentino Tyres
JK Tyres	-	

RDA Reg No. RDASR **0997**

35 Energynet (Pvt) Ltd Specilized Products / Brands Business Reg. No

180, Deans Rd, Colombo 10

0112448518

0112448517

info@hayleysfentons.com

Vertiv	Tescom	-
-	-	

RDA Reg No. RDASR **1041**

36 S.K.M.Tyres (Pvt) Ltd Specilized Products / Brands Business Reg. No

56/A, S.D.S.Jayasinghe Mw, Kohuwala, Nugegoda

0114201201

















0112828288

iranda@skmtyres.lk/sujith@skmtyres.lk





















-	-	-
-	-	

RDA Reg No. RDASR **01048**

1.30 Uniform Items (Shoes, Slippers, Boots, Rain Coats, Bag, Brief Cases, Etc)

























1	Piyasasa and Sons  No.34, Galwala Rd, Colombo 12  0112435871/0112321324  0112440181  piyadasasons2018@gmail.com	Specilized Products / Brands <table border="1"> <tr> <td>-</td> <td>-</td> <td>-</td> </tr> <tr> <td>-</td> <td>-</td> <td></td> </tr> </table>	-	-	-	-	-		Business Reg. No W4069 RDA Reg No. RDASR 0026
-	-	-							
-	-								
2	Pryda Enterprise  No.03, Adbul Hameed Street, Colombo 12  0112321325/0112321023  0112440181  prydak@gmail.com/pryda.info@gmail.com	Specilized Products / Brands <table border="1"> <tr> <td>-</td> <td>-</td> <td>-</td> </tr> <tr> <td>-</td> <td>-</td> <td></td> </tr> </table>	-	-	-	-	-		Business Reg. No WA205539 RDA Reg No. RDASR 0095
-	-	-							
-	-								
3	Best Energy Solution Technology (Pvt) Ltd  No.1/3, Janajayapura Mini City, Obeysekarapura, Rajagiriya  0112867026/0778315754  -  info@bestenergy.lk	Specilized Products / Brands <table border="1"> <tr> <td>-</td> <td>-</td> <td>-</td> </tr> <tr> <td>-</td> <td>-</td> <td></td> </tr> </table>	-	-	-	-	-		Business Reg. No PV108247 RDA Reg No. RDASR 0178
-	-	-							
-	-								
4	4M International (Pvt) Ltd  No.137, High level Rd, Kendalanda, Homagama  0112098417  0112098417  info@4minternational.lk/info@4minternation	Specilized Products / Brands <table border="1"> <tr> <td>-</td> <td>-</td> <td>-</td> </tr> <tr> <td>-</td> <td>-</td> <td></td> </tr> </table>	-	-	-	-	-		Business Reg. No PV98050 RDA Reg No. RDASR 0188
-	-	-							
-	-								
5	Marshal Trading Company  No.232, Old Moor Street, Colombo 12  0112343452/0112340105-8  0112333256  marshaltradesupply@gmail.com	Specilized Products / Brands <table border="1"> <tr> <td>Prime Road</td> <td>Thermo Plastic</td> <td>-</td> </tr> <tr> <td>-</td> <td>-</td> <td></td> </tr> </table>	Prime Road	Thermo Plastic	-	-	-		Business Reg. No RDA Reg No. RDASR 0371
Prime Road	Thermo Plastic	-							
-	-								
6	Marshal Trading Company  No.232, Old Moor Street, Colombo 12  0112343452/0112340105-8  0112333256  marshaltradesupply@gmail.com	Specilized Products / Brands <table border="1"> <tr> <td>Prime Road</td> <td>Thermo Plastic</td> <td>-</td> </tr> <tr> <td>-</td> <td>-</td> <td></td> </tr> </table>	Prime Road	Thermo Plastic	-	-	-		Business Reg. No RDA Reg No. RDASR 0371
Prime Road	Thermo Plastic	-							
-	-								

1.30 Uniform Items (Shoes, Slippers, Boots, Rain Coats, Bag, Brief Cases, Etc)

7	Galle City Suppliers (Pvt) Ltd	Specilized Products / Brands	Business Reg. No						
	No.69, Main Street, Kaduruwela	<table border="1"><tr><td>-</td><td>-</td><td>-</td></tr><tr><td>-</td><td>-</td><td></td></tr></table>	-	-	-	-	-		
-	-	-							
-	-								
	0272056205								
	-								
	gallecitystores7@gmail.com	RDA Reg No.	RDASR 0450						
8	Rainwear Apprel (Pvt) Ltd	Specilized Products / Brands	Business Reg. No						
	Badulla Rd, Binddunuwewa, Bandarawela	<table border="1"><tr><td>-</td><td>-</td><td>-</td></tr><tr><td>-</td><td>-</td><td></td></tr></table>	-	-	-	-	-		
-	-	-							
-	-								
	0777371752/0572232657								
	0572232657								
	rainwearapparel@yahoo.com	RDA Reg No.	RDASR 0466						
9	Beta shoe Company of Ceylon Ltd	Specilized Products / Brands	Business Reg. No						
	100, Sir John Kotalawala rd, Rathmalana	<table border="1"><tr><td>Bata</td><td>Power</td><td>Spars</td></tr><tr><td>Hush puppies</td><td>B.first</td><td></td></tr></table>	Bata	Power	Spars	Hush puppies	B.first		
Bata	Power	Spars							
Hush puppies	B.first								
	0112633791/2								
	0112637093								
	janidu.weerasinghe@bata.com/asiri.edward	RDA Reg No.	RDASR 0477						
10	T.D.R.Engineering and Construction	Specilized Products / Brands	Business Reg. No						
	No.08, Good Shed Rd, Rathnapura	<table border="1"><tr><td>-</td><td>-</td><td>-</td></tr><tr><td>-</td><td>-</td><td></td></tr></table>	-	-	-	-	-		
-	-	-							
-	-								
	0717850600								
	0452222118								
	tdrengineeringc@gmail.com	RDA Reg No.	RDASR 0817						
11	Fresh Line Safety Products (Pvt) ltd	Specilized Products / Brands	Business Reg. No						
	No.13, Nagenahira Mw, Kirillawala, Kadawatha	<table border="1"><tr><td>-</td><td>-</td><td>-</td></tr><tr><td>-</td><td>-</td><td></td></tr></table>	-	-	-	-	-		
-	-	-							
-	-								
	0113145300								
	0113145300								
	accounts@freshlinesafety.com	RDA Reg No.	RDASR 0959						

1.31 Uniform Materials

(Trousers, Shirting, Sarong, Saree, Labour Jackets etc.)

1	Asoka Textiles	Specilized Products / Brands	Business Reg. No	W/A34702						
	180/3/16, Keyzer Street, Colombo 11	<table border="1"><tr><td>-</td><td>-</td><td>-</td></tr><tr><td>-</td><td>-</td><td>-</td></tr></table>	-	-	-	-	-	-		
-	-	-								
-	-	-								
	0112384243									
	0112384243									
	asokatex@gmail.com		RDA Reg No.	RDASR 0005						
2	Five Stare Textiles Centre	Specilized Products / Brands	Business Reg. No	W/A6654						
	No.95, second Cross Street, Colombo 11	<table border="1"><tr><td>-</td><td>-</td><td>-</td></tr><tr><td>-</td><td>-</td><td>-</td></tr></table>	-	-	-	-	-	-		
-	-	-								
-	-	-								
	0112441810/0112345280									
	0112345184									
	sstarcurlains@gmail.com		RDA Reg No.	RDASR 0024						
3	Lithumethas	Specilized Products / Brands	Business Reg. No	WA54581						
	No.19/A, Keyzer Street, Colombo 11	<table border="1"><tr><td>Clothing Material</td><td>-</td><td>-</td></tr><tr><td>-</td><td>-</td><td>-</td></tr></table>	Clothing Material	-	-	-	-	-		
Clothing Material	-	-								
-	-	-								
	0113136908/0112432106									
	0112432106									
	lithumethas@sltnet.lk		RDA Reg No.	RDASR 0131						
4	Ganesh Textiles (Pvt) Ltd	Specilized Products / Brands	Business Reg. No	PV4871						
	81-83, Main Street, Colombo 11	<table border="1"><tr><td>-</td><td>-</td><td>-</td></tr><tr><td>-</td><td>-</td><td>-</td></tr></table>	-	-	-	-	-	-		
-	-	-								
-	-	-								
	0112325128									
	0112458937									
	ganesh textiles81@gmail.com		RDA Reg No.	RDASR 0225						
5	Rainwear Apprel (Pvt) Ltd	Specilized Products / Brands	Business Reg. No							
	Badulla Rd, Binddunuwewa, Bandarawela	<table border="1"><tr><td>-</td><td>-</td><td>-</td></tr><tr><td>-</td><td>-</td><td>-</td></tr></table>	-	-	-	-	-	-		
-	-	-								
-	-	-								
	0777371752/0572232657									
	0572232657									
	rainwearapparel@yahoo.com		RDA Reg No.	RDASR 0466						
6	T.D.R.Engineering and Construction	Specilized Products / Brands	Business Reg. No							
	No.08, Good Shed Rd, Rathnapura	<table border="1"><tr><td>-</td><td>-</td><td>-</td></tr><tr><td>-</td><td>-</td><td>-</td></tr></table>	-	-	-	-	-	-		
-	-	-								
-	-	-								
	0717850600									
	0452222118									
	tdengineeringc@gmail.com		RDA Reg No.	RDASR 0817						

1.31 Uniform Materials

(Trousers, Shirting, Sarong, Saree, Labour Jackets etc.)

7 **redhi House Tangalle**



No.112/1/1, Tissa rd, Tangalle



0718210566



-



mikram869@gmail.com

Specilized Products / Brands

Business Reg.
No

-	-	-
-	-	

RDA Reg No.

RDASR

01057

1.32 Water Boilers

1 **Brown & Company PLC**

Specilized Products / Brands

Business Reg.
No

PQ25



No.34, Sir Mohamed Macan Markar Mw,
Colombo 03

-	-	-
-	-	



0115063280



0112307377



























procurement@brownsgroup.com

RDA Reg No.

























RDASR

0736

1.33 Workshop Equipment and Tools

1	Hunters and Company PLC  45/75, Narahenpita rd, Colombo 05  0112081700-Ext-247/0711413515  0112368420  fse1@hunters.lk / sales@hunters.lk	Specilized Products / Brands <table border="1"> <tbody> <tr> <td>-</td> <td>-</td> <td>-</td> </tr> <tr> <td>-</td> <td>-</td> <td></td> </tr> </tbody> </table>	-	-	-	-	-		Business Reg. No PQ226 RDA Reg No. RDASR 0002
-	-	-							
-	-								
2	Matrix (Private) Ltd  No.850, Bulugaja Junction, Kandy rd, Dalugama, Kelaniya  0114377313  0112912487  matrix@slt.lk / matrix@matrix.com	Specilized Products / Brands <table border="1"> <tbody> <tr> <td>-</td> <td>-</td> <td>-</td> </tr> <tr> <td>-</td> <td>-</td> <td></td> </tr> </tbody> </table>	-	-	-	-	-		Business Reg. No PV648 RDA Reg No. RDASR 0009
-	-	-							
-	-								
3	Asean Industrial Tradeways  307, Old Moor Street, Colombo 12  0112448332/0112433070  0112320526  tradeways@slt.lk	Specilized Products / Brands <table border="1"> <tbody> <tr> <td>-</td> <td>-</td> <td>-</td> </tr> <tr> <td>-</td> <td>-</td> <td></td> </tr> </tbody> </table>	-	-	-	-	-		Business Reg. No W/11919 RDA Reg No. RDASR 0011
-	-	-							
-	-								
4	Arenya Trader  No.320/8/B, Hendala Rd, Hendala, Wattala  0112931464  0112931464  arenya6@sltnet.lk	Specilized Products / Brands <table border="1"> <tbody> <tr> <td>-</td> <td>-</td> <td>-</td> </tr> <tr> <td>-</td> <td>-</td> <td></td> </tr> </tbody> </table>	-	-	-	-	-		Business Reg. No W/T/1/8881 RDA Reg No. RDASR 0038
-	-	-							
-	-								
5	Mahajana Hardware  No.90, Main Street, Anuradhaoura  0252223901  0252223902  nazeer.mahajana@gmail.com	Specilized Products / Brands <table border="1"> <tbody> <tr> <td>-</td> <td>-</td> <td>-</td> </tr> <tr> <td>-</td> <td>-</td> <td></td> </tr> </tbody> </table>	-	-	-	-	-		Business Reg. No RDA Reg No. RDASR 0053
-	-	-							
-	-								
6	A.C.Paul & Co.Ltd  324,326, Sri Sangaraja Mw' Colombo 10  0112431018-19  0112421209  info@cacpaul.lk	Specilized Products / Brands <table border="1"> <tbody> <tr> <td>Ura- Hand Tools</td> <td>Dormer-D Rill Bits</td> <td>Daesan- Chain Block</td> </tr> <tr> <td>Lathe Tool</td> <td>Larzep- Hydraulic</td> <td></td> </tr> </tbody> </table>	Ura- Hand Tools	Dormer-D Rill Bits	Daesan- Chain Block	Lathe Tool	Larzep- Hydraulic		Business Reg. No RDA Reg No. RDASR 0077
Ura- Hand Tools	Dormer-D Rill Bits	Daesan- Chain Block							
Lathe Tool	Larzep- Hydraulic								

1.33 Workshop Equipment and Tools

7	4M International (Pvt) Ltd	Specilized Products / Brands	Business Reg. No						
	No.137, High level Rd, Kendalanda, Homagama	<table border="1"><tr><td>-</td><td>-</td><td>-</td></tr><tr><td>-</td><td>-</td><td></td></tr></table>	-	-	-	-	-		
-	-	-							
-	-								
	0112098417								
	0112098417								
	info@4minternational.lk/info@4minternation	RDA Reg No.	RDASR 0188						
8	Alcobronz Engineering (Pvt) Ltd	Specilized Products / Brands	Business Reg. No						
	130/16, Major Wasantha Gunarathna Mw, Mahara, Kadawatha	<table border="1"><tr><td>Richyoun g</td><td>Robland</td><td>Bromac</td></tr><tr><td>Luman</td><td>Amco</td><td></td></tr></table>	Richyoun g	Robland	Bromac	Luman	Amco		
Richyoun g	Robland	Bromac							
Luman	Amco								
	0112925023								
	0112926859								
	tenders@alcobronz.com/info@alcobronz.co	RDA Reg No.	RDASR 0190						
9	Cooper International	Specilized Products / Brands	Business Reg. No						
	No.293, 1/1, Old Moor Street, Colombo 12	<table border="1"><tr><td>-</td><td>-</td><td>-</td></tr><tr><td>-</td><td>-</td><td></td></tr></table>	-	-	-	-	-		
-	-	-							
-	-								
	0112433659								
	0112337149								
	info@cooper-international.net	RDA Reg No.	RDASR 0251						
10	Marlbon Trading Company	Specilized Products / Brands	Business Reg. No						
	No.24, Abdul Gaffoor Mw, Colombo 03	<table border="1"><tr><td>KYORITS U</td><td>FLUKE</td><td>GW INSTEC</td></tr><tr><td>JINAN BADA</td><td>HABIN & SAFETY</td><td></td></tr></table>	KYORITS U	FLUKE	GW INSTEC	JINAN BADA	HABIN & SAFETY		
KYORITS U	FLUKE	GW INSTEC							
JINAN BADA	HABIN & SAFETY								
	0112576999								
	0112577872								
	marlbo@sltnet.lk	RDA Reg No.	RDASR 0367						
11	Diesel & Motor Engineering PLC	Specilized Products / Brands	Business Reg. No						
	No.65, Jethamana Rd, Colombo 14	<table border="1"><tr><td>-</td><td>-</td><td>-</td></tr><tr><td>-</td><td>-</td><td></td></tr></table>	-	-	-	-	-		
-	-	-							
-	-								
	0112449797/0112338883								
	0112449080								
	dimo@dimolanka.com	RDA Reg No.	RDASR 0476						
12	Brown & Company PLC	Specilized Products / Brands	Business Reg. No						
	No.34, Sir Mohamed Macan Markar Mw, Colombo 03	<table border="1"><tr><td>-</td><td>-</td><td>-</td></tr><tr><td>-</td><td>-</td><td></td></tr></table>	-	-	-	-	-		
-	-	-							
-	-								
	0115063280								
	0112307377								
	procurement@brownsgroup.com	RDA Reg No.	RDASR 0736						

1.34 Workshop Hardware

Grinding Disk, Hacksaw Blades and Sand Papers etc

1	Asean Industrial Tradeways	Specilized Products / Brands	Business Reg. No	W/11919						
	307, Old Moor Street, Colombo 12	<table border="1"> <tr><td>-</td><td>-</td><td>-</td></tr> <tr><td>-</td><td>-</td><td></td></tr> </table>	-	-	-	-	-			
-	-	-								
-	-									
	0112448332/0112433070									
	0112320526									
	tradeways@slt.lk		RDA Reg No.	RDASR 0011						
2	Mahajana Hardware	Specilized Products / Brands	Business Reg. No	NCP0025						
	No.90, Main Street, Anuradhaoura	<table border="1"> <tr><td>-</td><td>-</td><td>-</td></tr> <tr><td>-</td><td>-</td><td></td></tr> </table>	-	-	-	-	-			
-	-	-								
-	-									
	0252223901									
	0252223902									
	nazeer.mahajana@gmail.com		RDA Reg No.	RDASR 0053						
3	C.W.Mackie PLC	Specilized Products / Brands	Business Reg. No	PQ47/08/08/2008						
	IPD, No.36, D.R.Wijewardana Mw, Colombo 10	<table border="1"> <tr><td>E.30</td><td>1.8</td><td>1.34</td></tr> <tr><td>1.38</td><td>1.39</td><td></td></tr> </table>	E.30	1.8	1.34	1.38	1.39			
E.30	1.8	1.34								
1.38	1.39									
	0112423554-62									
	0112331100									
	sales@ipd.cwmackie.com/ipd@cwmackie.c		RDA Reg No.	RDASR 0107						
4	4M International (Pvt) Ltd	Specilized Products / Brands	Business Reg. No	PV98050						
	No.137, High level Rd, Kendalanda, Homagama	<table border="1"> <tr><td>-</td><td>-</td><td>-</td></tr> <tr><td>-</td><td>-</td><td></td></tr> </table>	-	-	-	-	-			
-	-	-								
-	-									
	0112098417									
	0112098417									
	info@4minternational.lk/info@4minternation		RDA Reg No.	RDASR 0188						
5	Sayaush Suppliers	Specilized Products / Brands	Business Reg. No							
	396, Hendala Rd, Wattala	<table border="1"> <tr><td>S.L.Airforce</td><td>S.L.Ports Authority</td><td>S.L.Navy</td></tr> <tr><td>-</td><td>-</td><td></td></tr> </table>	S.L.Airforce	S.L.Ports Authority	S.L.Navy	-	-			
S.L.Airforce	S.L.Ports Authority	S.L.Navy								
-	-									
	0112932106									
	0112932106									
	subaji410@gmail.com		RDA Reg No.	RDASR 0253						
6	Carson Enterprises	Specilized Products / Brands	Business Reg. No							
	No.14, Quarry Rd, Colombo 12	<table border="1"> <tr><td>SL Railway</td><td>SL ARMY</td><td>SL Air Force</td></tr> <tr><td>SL Navy</td><td>SL Ports Authority</td><td></td></tr> </table>	SL Railway	SL ARMY	SL Air Force	SL Navy	SL Ports Authority			
SL Railway	SL ARMY	SL Air Force								
SL Navy	SL Ports Authority									
	0112438963/0112438965									
	0112438964									
	carson314@gmail.com		RDA Reg No.	RDASR 0255						

1.34 Workshop Hardware

Grinding Disk, Hacksaw Blades and Sand Papers etc

7 Diesel & Motor Engineering PLC



No.65, Jethamana Rd, Colombo 14



0112449797/0112338883



0112449080



dimo@dimolanka.com

Specilized Products / Brands

Business
Reg. No

-	-	-
---	---	---

-	-	
---	---	--

RDA Reg No.

RDASR **0476**

8 Sri Sun Steel



No.457, Old Moor Street, Colombo 12



0112322701/0112336250



0114641880



info@srisunsteel.lk

Specilized Products / Brands

Business
Reg. No

-	-	-
---	---	---

-	-	
---	---	--

RDA Reg No.

RDASR **0534**

9 T.D.R.Engineering and Construction



No.08, Good Shed Rd, Rathnapura



0717850600



0452222118



tdengineeringc@gmail.com

Specilized Products / Brands

Business
Reg. No

-	-	-
---	---	---

-	-	
---	---	--

RDA Reg No.

RDASR **0817**

10 S/L State Trading (General) Corporation Ltd



No.100, Nawam Mw, Colombo 02



0112422342/4



0112447970



lankagen@slt.net.lk

Specilized Products / Brands

Business
Reg. No

Nano mask	STC Mask	STC Sanitizers
--------------	-------------	-------------------

























-	-	
---	---	--

RDA Reg No.

RDASR **0881**

1.35 Workshop Hardware

Machine Tools, Jumper and High Speed Steel etc

1	Asean Industrial Tradeways  307, Old Moor Street, Colombo 12  0112448332/0112433070  0112320526  tradeways@slt.lk	Specilized Products / Brands <table border="1"> <tbody> <tr> <td>-</td> <td>-</td> <td>-</td> </tr> <tr> <td>-</td> <td>-</td> <td></td> </tr> </tbody> </table>	-	-	-	-	-		Business Reg. No W/11919 RDA Reg No. RDASR 0011
-	-	-							
-	-								
2	Mahajana Hardware  No.90, Main Street, Anuradhaoura  0252223901  0252223902  nazeer.mahajana@gmail.com	Specilized Products / Brands <table border="1"> <tbody> <tr> <td>-</td> <td>-</td> <td>-</td> </tr> <tr> <td>-</td> <td>-</td> <td></td> </tr> </tbody> </table>	-	-	-	-	-		Business Reg. No NCP0025 RDA Reg No. RDASR 0053
-	-	-							
-	-								
3	4M International (Pvt) Ltd  No.137, High level Rd, Kendalanda, Homagama  0112098417  0112098417  info@4minternational.lk/info@4minternation	Specilized Products / Brands <table border="1"> <tbody> <tr> <td>-</td> <td>-</td> <td>-</td> </tr> <tr> <td>-</td> <td>-</td> <td></td> </tr> </tbody> </table>	-	-	-	-	-		Business Reg. No PV98050 RDA Reg No. RDASR 0188
-	-	-							
-	-								
4	Cooper International  No.293, 1/1, Old Moor Street, Colombo 12  0112433659  0112337149  info@cooper-international.net	Specilized Products / Brands <table border="1"> <tbody> <tr> <td>-</td> <td>-</td> <td>-</td> </tr> <tr> <td>-</td> <td>-</td> <td></td> </tr> </tbody> </table>	-	-	-	-	-		Business Reg. No W/A2998 RDA Reg No. RDASR 0251
-	-	-							
-	-								
5	Carson Enterprises  No.14, Quarry Rd, Colombo 12  0112438963/0112438965  0112438964  carson314@gmail.com	Specilized Products / Brands <table border="1"> <tbody> <tr> <td>SL Railway</td> <td>SL ARMY</td> <td>SL Air Force</td> </tr> <tr> <td>SL Navy</td> <td>SL Ports Authority</td> <td></td> </tr> </tbody> </table>	SL Railway	SL ARMY	SL Air Force	SL Navy	SL Ports Authority		Business Reg. No RDA Reg No. RDASR 0255
SL Railway	SL ARMY	SL Air Force							
SL Navy	SL Ports Authority								
6	Marshal Trading Company  No.232, Old Moor Street, Colombo 12  0112343452/0112340105-8  0112333256  marshaltradesupply@gmail.com	Specilized Products / Brands <table border="1"> <tbody> <tr> <td>Prime Road</td> <td>Thermo Plastic</td> <td>-</td> </tr> <tr> <td>-</td> <td>-</td> <td></td> </tr> </tbody> </table>	Prime Road	Thermo Plastic	-	-	-		Business Reg. No RDA Reg No. RDASR 0371
Prime Road	Thermo Plastic	-							
-	-								

7 **Brown & Company PLC**



No.34, Sir Mohamed Macan Markar Mw,
Colombo 03



0115063280



0112307377



procurement@brownsgroup.com

Specilized Products / Brands

Business
Reg. No

-	-	-
-	-	

RDA Reg No.

























RDASR **0736**

1.36 Workshop Hardware Non Ferrous Metal (Alluminum, Brass and Bronze etc)

1	Asean Industrial Tradeways	Specilized Products / Brands	Business Reg. No	W/11919						
	307, Old Moor Street, Colombo 12	<table border="1"><tr><td>-</td><td>-</td><td>-</td></tr><tr><td>-</td><td>-</td><td></td></tr></table>	-	-	-	-	-			
-	-	-								
-	-									
	0112448332/0112433070									
	0112320526									
	tradeways@slt.lk		RDA Reg No.	RDASR 0011						
2	Mahajana Hardware	Specilized Products / Brands	Business Reg. No	NCP0025						
	No.90, Main Street, Anuradhaoura	<table border="1"><tr><td>-</td><td>-</td><td>-</td></tr><tr><td>-</td><td>-</td><td></td></tr></table>	-	-	-	-	-			
-	-	-								
-	-									
	0252223901									
	0252223902									
	nazeer.mahajana@gmail.com		RDA Reg No.	RDASR 0053						
3	Cooper International	Specilized Products / Brands	Business Reg. No	W/A2998						
	No.293, 1/1, Old Moor Street, Colombo 12	<table border="1"><tr><td>-</td><td>-</td><td>-</td></tr><tr><td>-</td><td>-</td><td></td></tr></table>	-	-	-	-	-			
-	-	-								
-	-									
	0112433659									
	0112337149									
	info@cooper-international.net		RDA Reg No.	RDASR 0251						
4	Marshal Trading Company	Specilized Products / Brands	Business Reg. No	WA2865						
	No.232, Old Moor Street, Colombo 12	<table border="1"><tr><td>Prime Road</td><td>Thermo Plastic</td><td>-</td></tr><tr><td>-</td><td>-</td><td></td></tr></table>	Prime Road	Thermo Plastic	-	-	-			
Prime Road	Thermo Plastic	-								
-	-									
	0112343452/0112340105-8									
	0112333256									
	marshaltradesupply@gmail.com		RDA Reg No.	RDASR 0371						
5	A.G.P.Holdings (Pvt) Ltd	Specilized Products / Brands	Business Reg. No							
	Elapahala Junction, Angulugaha, Galle	<table border="1"><tr><td>-</td><td>-</td><td>-</td></tr><tr><td>-</td><td>-</td><td></td></tr></table>	-	-	-	-	-			
-	-	-								
-	-									
	0913094645									
	-									
	agpholding@gmail.com		RDA Reg No.	RDASR 0555						
6	T.D.R.Engineering and Construction	Specilized Products / Brands	Business Reg. No							
	No.08, Good Shed Rd, Rathnapura	<table border="1"><tr><td>-</td><td>-</td><td>-</td></tr><tr><td>-</td><td>-</td><td></td></tr></table>	-	-	-	-	-			
-	-	-								
-	-									
	0717850600									
	0452222118									
	tdengineeringc@gmail.com		RDA Reg No.	RDASR 0817						

1.37 Workshop Hardware

PVC Tubes, Poly Ethylene & Poly Propylene Product

1	Asean Industrial Tradeways  307, Old Moor Street, Colombo 12  0112448332/0112433070  0112320526  tradeways@slt.lk	Specilized Products / Brands <table border="1"> <tbody> <tr> <td>-</td> <td>-</td> <td>-</td> </tr> <tr> <td>-</td> <td>-</td> <td></td> </tr> </tbody> </table>	-	-	-	-	-		Business Reg. No W/11919 RDA Reg No. RDASR 0011
-	-	-							
-	-								
2	Piyasasa and Sons  No.34, Galwala Rd, Colombo 12  0112435871/0112321324  0112440181  piyadasasons2018@gmail.com	Specilized Products / Brands <table border="1"> <tbody> <tr> <td>-</td> <td>-</td> <td>-</td> </tr> <tr> <td>-</td> <td>-</td> <td></td> </tr> </tbody> </table>	-	-	-	-	-		Business Reg. No W4069 RDA Reg No. RDASR 0026
-	-	-							
-	-								
3	Mahajana Hardware  No.90, Main Street, Anuradhaoura  0252223901  0252223902  nazeer.mahajana@gmail.com	Specilized Products / Brands <table border="1"> <tbody> <tr> <td>-</td> <td>-</td> <td>-</td> </tr> <tr> <td>-</td> <td>-</td> <td></td> </tr> </tbody> </table>	-	-	-	-	-		Business Reg. No NCP0025 RDA Reg No. RDASR 0053
-	-	-							
-	-								
4	Pryda Enterprise  No.03, Abdul Hameed Street, Colombo 12  0112321325/0112321023  0112440181  prydalk@gmail.com/pryda.info@gmail.com	Specilized Products / Brands <table border="1"> <tbody> <tr> <td>-</td> <td>-</td> <td>-</td> </tr> <tr> <td>-</td> <td>-</td> <td></td> </tr> </tbody> </table>	-	-	-	-	-		Business Reg. No WA205539 RDA Reg No. RDASR 0095
-	-	-							
-	-								
5	Sayaush Suppliers  396, Hendala Rd, Wattala  0112932106  0112932106  subaji410@gmail.com	Specilized Products / Brands <table border="1"> <tbody> <tr> <td>S.L.Airforce</td> <td>S.L.Ports Authority</td> <td>S.L.Navy</td> </tr> <tr> <td>-</td> <td>-</td> <td></td> </tr> </tbody> </table>	S.L.Airforce	S.L.Ports Authority	S.L.Navy	-	-		Business Reg. No RDA Reg No. RDASR 0253
S.L.Airforce	S.L.Ports Authority	S.L.Navy							
-	-								
6	Carson Enterprises  No.14, Quarry Rd, Colombo 12  0112438963/0112438965  0112438964  carson314@gmail.com	Specilized Products / Brands <table border="1"> <tbody> <tr> <td>SL Railway</td> <td>SL ARMY</td> <td>SL Air Force</td> </tr> <tr> <td>SL Navy</td> <td>SL Ports Authority</td> <td></td> </tr> </tbody> </table>	SL Railway	SL ARMY	SL Air Force	SL Navy	SL Ports Authority		Business Reg. No RDA Reg No. RDASR 0255
SL Railway	SL ARMY	SL Air Force							
SL Navy	SL Ports Authority								

1.37 Workshop Hardware

PVC Tubes, Poly Ethylene & Poly Propylene Product

7 Marshal Trading Company



No.232, Old Moor Street, Colombo 12



0112343452/0112340105-8



0112333256



marshaltradesupply@gmail.com

Specilized Products / Brands

Business
Reg. No

Prime Road	Thermo Plastic	-
-	-	

RDA Reg No.

RDASR 0371

8 T.D.R.Engineering and Construction



No.08, Good Shed Rd, Rathnapura



0717850600



0452222118



tdengineeringc@gmail.com

Specilized Products / Brands

Business
Reg. No

























-	-	-
-	-	

RDA Reg No.

RDASR 0817

1.38 Workshop Hardware

Steel, Angle Iron, Channels, Bars, Tubes, Sheet Metals

1	Asean Industrial Tradeways	Specilized Products / Brands	Business Reg. No	W/11919						
	307, Old Moor Street, Colombo 12	<table border="1"><tr><td>-</td><td>-</td><td>-</td></tr><tr><td>-</td><td>-</td><td></td></tr></table>	-	-	-	-	-			
-	-	-								
-	-									
	0112448332/0112433070									
	0112320526									
	tradeways@slt.lk		RDA Reg No.	RDASR 0011						
2	Mahajana Hardware	Specilized Products / Brands	Business Reg. No	NCP0025						
	No.90, Main Street, Anuradhaoura	<table border="1"><tr><td>-</td><td>-</td><td>-</td></tr><tr><td>-</td><td>-</td><td></td></tr></table>	-	-	-	-	-			
-	-	-								
-	-									
	0252223901									
	0252223902									
	nazeer.mahajana@gmail.com		RDA Reg No.	RDASR 0053						
3	C.W.Mackie PLC	Specilized Products / Brands	Business Reg. No	PQ47/08/08 /2008						
	IPD, No.36, D.R.Wijewardana Mw, Colombo 10	<table border="1"><tr><td>E.30</td><td>1.8</td><td>1.34</td></tr><tr><td>1.38</td><td>1.39</td><td></td></tr></table>	E.30	1.8	1.34	1.38	1.39			
E.30	1.8	1.34								
1.38	1.39									
	0112423554-62									
	0112331100									
	sales@ipd.cwmackie.com/ipd@cwmackie.c		RDA Reg No.	RDASR 0107						
4	Cooper International	Specilized Products / Brands	Business Reg. No	W/A2998						
	No.293, 1/1, Old Moor Street, Colombo 12	<table border="1"><tr><td>-</td><td>-</td><td>-</td></tr><tr><td>-</td><td>-</td><td></td></tr></table>	-	-	-	-	-			
-	-	-								
-	-									
	0112433659									
	0112337149									
	info@cooper-international.net		RDA Reg No.	RDASR 0251						
5	Sayaush Suppliers	Specilized Products / Brands	Business Reg. No							
	396, Hendala Rd, Wattala	<table border="1"><tr><td>S.L.Airforce</td><td>S.L.Ports Authority</td><td>S.L.Navy</td></tr><tr><td>-</td><td>-</td><td></td></tr></table>	S.L.Airforce	S.L.Ports Authority	S.L.Navy	-	-			
S.L.Airforce	S.L.Ports Authority	S.L.Navy								
-	-									
	0112932106									
	0112932106									
	subaji410@gmail.com		RDA Reg No.	RDASR 0253						
6	Carson Enterprises	Specilized Products / Brands	Business Reg. No							
	No.14, Quarry Rd, Colombo 12	<table border="1"><tr><td>SL Railway</td><td>SL ARMY</td><td>SL Air Force</td></tr><tr><td>SL Navy</td><td>SL Ports Authority</td><td></td></tr></table>	SL Railway	SL ARMY	SL Air Force	SL Navy	SL Ports Authority			
SL Railway	SL ARMY	SL Air Force								
SL Navy	SL Ports Authority									
	0112438963/0112438965									
	0112438964									
	carson314@gmail.com		RDA Reg No.	RDASR 0255						

7 **Marshal Trading Company**



No.232, Old Moor Street, Colombo 12



0112343452/0112340105-8



0112333256



marshaltradesupply@gmail.com

Specilized Products / Brands

Business
Reg. No

Prime Road	Thermo Plastic	-
-	-	

RDA Reg No.

RDASR **0371**

8 **Sri Sun Steel**



No.457, Old Moor Street, Colombo 12



0112322701/0112336250



0114641880



info@srisunsteel.lk

Specilized Products / Brands

Business
Reg. No

-	-	-
-	-	

RDA Reg No.

RDASR **0534**

1.39 Workshop Hardware

Welding Equipment and Electronics

1	Matrix (Private) Ltd	Specilized Products / Brands	Business Reg. No	PV648						
	No.850, Bulugaja Junction, Kandy rd, Dalugama, Kelaniya	<table border="1"><tr><td>-</td><td>-</td><td>-</td></tr><tr><td>-</td><td>-</td><td></td></tr></table>	-	-	-	-	-			
-	-	-								
-	-									
	0114377313									
	0112912487									
	matrix@slt.lk / matrix@matrix.com		RDA Reg No.	RDASR 0009						
2	Asean Industrial Tradeways	Specilized Products / Brands	Business Reg. No	W/11919						
	307, Old Moor Street, Colombo 12	<table border="1"><tr><td>-</td><td>-</td><td>-</td></tr><tr><td>-</td><td>-</td><td></td></tr></table>	-	-	-	-	-			
-	-	-								
-	-									
	0112448332/0112433070									
	0112320526									
	tradeways@slt.lk		RDA Reg No.	RDASR 0011						
3	Mahajana Hardware	Specilized Products / Brands	Business Reg. No	NCP0025						
	No.90, Main Street, Anuradhaoura	<table border="1"><tr><td>-</td><td>-</td><td>-</td></tr><tr><td>-</td><td>-</td><td></td></tr></table>	-	-	-	-	-			
-	-	-								
-	-									
	0252223901									
	0252223902									
	nazeer.mahajana@gmail.com		RDA Reg No.	RDASR 0053						
4	C.W.Mackie PLC	Specilized Products / Brands	Business Reg. No	PQ47/08/08/2008						
	IPD, No.36, D.R.Wijewardana Mw, Colombo 10	<table border="1"><tr><td>E.30</td><td>1.8</td><td>1.34</td></tr><tr><td>1.38</td><td>1.39</td><td></td></tr></table>	E.30	1.8	1.34	1.38	1.39			
E.30	1.8	1.34								
1.38	1.39									
	0112423554-62									
	0112331100									
	sales@ipd.cwmackie.com/ipd@cwmackie.c		RDA Reg No.	RDASR 0107						
5	Cooper International	Specilized Products / Brands	Business Reg. No							
	No.293, 1/1, Old Moor Street, Colombo 12	<table border="1"><tr><td>-</td><td>-</td><td>-</td></tr><tr><td>-</td><td>-</td><td></td></tr></table>	-	-	-	-	-			
-	-	-								
-	-									
	0112433659									
	0112337149									
	info@cooper-international.net		RDA Reg No.	RDASR 0251						
6	Marshal Trading Company	Specilized Products / Brands	Business Reg. No							
	No.232, Old Moor Street, Colombo 12	<table border="1"><tr><td>Prime Road</td><td>Thermo Plastic</td><td>-</td></tr><tr><td>-</td><td>-</td><td></td></tr></table>	Prime Road	Thermo Plastic	-	-	-			
Prime Road	Thermo Plastic	-								
-	-									
	0112343452/0112340105-8									
	0112333256									
	marshaltradesupply@gmail.com		RDA Reg No.	RDASR 0371						

6 **Diesel & Motor Engineering PLC**



No.65, Jethamana Rd, Colombo 14



0112449797/0112338883



0112449080



dimolanka.com

Specilized Products / Brands

Business
Reg. No

-	-	-
-	-	

RDA Reg No.

RDASR **0476**

1.40 Traffic Safety Equipment Cones, Gloves, Boots, Helmet, etc

1	Piyasasa and Sons	Specilized Products / Brands	Business Reg. No	W4069						
	No.34, Galwala Rd, Colombo 12	<table border="1"><tr><td>-</td><td>-</td><td>-</td></tr><tr><td>-</td><td>-</td><td></td></tr></table>	-	-	-	-	-			
-	-	-								
-	-									
	0112435871/0112321324									
	0112440181									
	piyadasasons2018@gmail.com		RDA Reg No.	RDASR 0026						
2	Mahajana Hardware	Specilized Products / Brands	Business Reg. No	NCP0025						
	No.90, Main Street, Anuradhaoura	<table border="1"><tr><td>-</td><td>-</td><td>-</td></tr><tr><td>-</td><td>-</td><td></td></tr></table>	-	-	-	-	-			
-	-	-								
-	-									
	0252223901									
	0252223902									
	nazeer.mahajana@gmail.com		RDA Reg No.	RDASR 0053						
3	Pryda Enterprise	Specilized Products / Brands	Business Reg. No	WA205539						
	No.03, Adbul Hameed Street, Colombo 12	<table border="1"><tr><td>-</td><td>-</td><td>-</td></tr><tr><td>-</td><td>-</td><td></td></tr></table>	-	-	-	-	-			
-	-	-								
-	-									
	0112321325/0112321023									
	0112440181									
	prydalk@gmail.com/pryda.info@gmail.co		RDA Reg No.	RDASR 0095						
4	Best Energy Solution Technology (Pvt) ltd	Specilized Products / Brands	Business Reg. No	PV108247						
	No.1/3, Janajayapura Mini City, Obeysekarapura, Rajagiriya	<table border="1"><tr><td>-</td><td>-</td><td>-</td></tr><tr><td>-</td><td>-</td><td></td></tr></table>	-	-	-	-	-			
-	-	-								
-	-									
	0112867026/0778315754									
	-									
	info@bestenergy.lk		RDA Reg No.	RDASR 0178						
5	Cooper International	Specilized Products / Brands	Business Reg. No							
	No.293, 1/1, Old Moor Street, Colombo 12	<table border="1"><tr><td>-</td><td>-</td><td>-</td></tr><tr><td>-</td><td>-</td><td></td></tr></table>	-	-	-	-	-			
-	-	-								
-	-									
	0112433659									
	0112337149									
	info@cooper-international.net		RDA Reg No.	RDASR 0251						
6	Marlbon Trading Company	Specilized Products / Brands	Business Reg. No							
	No.24, Abdul Gaffoor Mw, Colombo 03	<table border="1"><tr><td>KYORITS U</td><td>FLUKE</td><td>GW INSTEC</td></tr><tr><td>JINAN BADA</td><td>HABIN & SAFETY</td><td></td></tr></table>	KYORITS U	FLUKE	GW INSTEC	JINAN BADA	HABIN & SAFETY			
KYORITS U	FLUKE	GW INSTEC								
JINAN BADA	HABIN & SAFETY									
	0112576999									
	0112577872									

✉ marlbo@slt.net.lk

RDA Reg No. RDASR 0367

7 **Marshal Trading Company**

Specilized Products / Brands

Business
Reg. No

🏠 No.232, Old Moor Street, Colombo 12

Prime Road	Thermo Plastic	-
-	-	

☎ 0112343452/0112340105-8

📞 0112333256

✉ marshaltradesupply@gmail.com

RDA Reg No. RDASR 0371

8 **Sri Sun Steel**

Specilized Products / Brands

Business
Reg. No

🏠 No.457, Old Moor Street, Colombo 12

-	-	-
-	-	

☎ 0112322701/0112336250

📞 0114641880

✉ info@srisunsteel.lk

RDA Reg No. RDASR 0534

9 **T.D.R.Engineering and Construction**

Specilized Products / Brands

Business
Reg. No

🏠 No.08, Good Shed Rd, Rathnapura

-	-	-
-	-	

☎ 0717850600

📞 0452222118

✉ tdengineeringc@gmail.com

RDA Reg No. RDASR 0817

10 **S/L State Trading (General) Corporation Ltd**

Specilized Products / Brands

Business
Reg. No

🏠 No.100, Nawam Mw, Colombo 02

Nano mask	STC Mask	STC Sanitizers
-	-	

☎ 0112422342/4

📞 0112447970

✉ lankagen@slt.net.lk

RDA Reg No. RDASR 0881

11 **Fresh Line Safety Products (Pvt) Ltd** Specilized Products / Brands

Business
Reg. No

🏠 No.13, Nagenahira Mw, Kirillawala, Kadawatha

-	-	-
-	-	

☎ 0113145300

📞 0113145300

✉ accounts@freshlinesafety.com

RDA Reg No. RDASR 0959

12 **Wayamba Polymers (Pvt) Ltd**

Specilized Products / Brands

Business
Reg. No

🏠 No.15 B 1/1, Temple rd, Nawala, Rajagiriya

-	-	-
-	-	

☎ 0112886266/67

📞 0112876495

























✉ wayambapolymers@gmail.com

RDA Reg No. RDASR 1037

1.41 Health & Safety Material & Equipment

Sanatizer, Mask & Thermometer, etc

1	Sahabandu Motors	Specilized Products / Brands	Business Reg. No	WC20050						
	No.134/A, Piliyandala Rd, Maharagama	<table border="1"><tr><td>-</td><td>-</td><td>-</td></tr><tr><td>-</td><td>-</td><td>-</td></tr></table>	-	-	-	-	-	-		
-	-	-								
-	-	-								
	0112896595									
	-									
	dineshsahabandu123@gmail.com		RDA Reg No.	RDASR 0066						
2	Samarakoon Construction	Specilized Products / Brands	Business Reg. No	W/Ath/EI/1150 1						
	50/1/A, Sirimal Uyana, Walaliyadda, Ellakkala	<table border="1"><tr><td>-</td><td>-</td><td>-</td></tr><tr><td>-</td><td>-</td><td>-</td></tr></table>	-	-	-	-	-	-		
-	-	-								
-	-	-								
	0718172661/0333339074									
	-									
	samarakoonconstruction@email.com		RDA Reg No.	RDASR 0155						
3	Initiative Development Agency Holdings Pvt Ltd	Specilized Products / Brands	Business Reg. No	PV130175						
	No.23/1, Sirimalwatta (West), Gunnepana, Kandy	<table border="1"><tr><td>-</td><td>-</td><td>-</td></tr><tr><td>-</td><td>-</td><td>-</td></tr></table>	-	-	-	-	-	-		
-	-	-								
-	-	-								
	0712728224/0812494560									
	-									
	ideahpvt@gmail.com		RDA Reg No.	RDASR 0159						
4	Best Energy Solution Technology (Pvt) Ltd	Specilized Products / Brands	Business Reg. No	PV108247						
	No.1/3, Janajayapura Mini City, Obeysekarapura, Rajagiriya	<table border="1"><tr><td>-</td><td>-</td><td>-</td></tr><tr><td>-</td><td>-</td><td>-</td></tr></table>	-	-	-	-	-	-		
-	-	-								
-	-	-								
	0112867026/0778315754									
	-									
	info@bestenergy.lk		RDA Reg No.	RDASR 0178						
5	Marshal Trading Company	Specilized Products / Brands	Business Reg. No							
	No.232, Old Moor Street, Colombo 12	<table border="1"><tr><td>Prime Road</td><td>Thermo Plastic</td><td>-</td></tr><tr><td>-</td><td>-</td><td>-</td></tr></table>	Prime Road	Thermo Plastic	-	-	-	-		
Prime Road	Thermo Plastic	-								
-	-	-								
	0112343452/0112340105-8									
	0112333256									
	marshaltradesupply@gmail.com		RDA Reg No.	RDASR 0371						
6	Ontarc (Pvt) Ltd	Specilized Products / Brands	Business Reg. No							
	137, Mahena Rd, Siyambalape	<table border="1"><tr><td>-</td><td>-</td><td>-</td></tr><tr><td>-</td><td>-</td><td>-</td></tr></table>	-	-	-	-	-	-		
-	-	-								
-	-	-								
	0114740954									
	0114740954									
	ontarc@sltnet.lk		RDA Reg No.	RDASR 0489						

7	Analytical Instruments (Pvt) Ltd	Specilized Products / Brands	Business Reg. No						
	No.100, Elvitigala Mw, Colombo 08	<table border="1"><tr><td>-</td><td>-</td><td>-</td></tr><tr><td>-</td><td>-</td><td></td></tr></table>	-	-	-	-	-		
-	-	-							
-	-								
	0112639000								
	0112699282								
	analytical@aipi.lk	RDA Reg No.	RDASR 0490						
8	Royal Paints Lanka (Pvt) Ltd	Specilized Products / Brands	Business Reg. No						
	No.271/1,"Isuru Uyana", Batapotha, Madelgamuwa, Gampaha	<table border="1"><tr><td>Paints</td><td>Sanitizer</td><td>-</td></tr><tr><td>-</td><td>-</td><td></td></tr></table>	Paints	Sanitizer	-	-	-		
Paints	Sanitizer	-							
-	-								
	0332237513/0710740194								
	0332237519								
	bennat@royalpaint.lk	RDA Reg No.	RDASR 0654						
9	T.D.R.Engineering and Construction	Specilized Products / Brands	Business Reg. No						
	No.08, Good Shed Rd, Rathnapura	<table border="1"><tr><td>-</td><td>-</td><td>-</td></tr><tr><td>-</td><td>-</td><td></td></tr></table>	-	-	-	-	-		
-	-	-							
-	-								
	0717850600								
	0452222118								
	tdengineeringc@gmail.com	RDA Reg No.	RDASR 0817						
10	S/L State Trading (General) Corporation Ltd	Specilized Products / Brands	Business Reg. No						
	No.100, Nawam Mw, Colombo 02	<table border="1"><tr><td>Nano mask</td><td>STC Mask</td><td>STC Sanitizers</td></tr><tr><td>-</td><td>-</td><td></td></tr></table>	Nano mask	STC Mask	STC Sanitizers	-	-		
Nano mask	STC Mask	STC Sanitizers							
-	-								
	0112422342/4								
	0112447970								
	lankagen@sltnet.lk	RDA Reg No.	RDASR 0881						
11	Fresh Line Safety Products (Pvt) Ltd	Specilized Products / Brands	Business Reg. No						
	No.13, Nagenahira Mw, Kirillawala, Kadawatha	<table border="1"><tr><td>-</td><td>-</td><td>-</td></tr><tr><td>-</td><td>-</td><td></td></tr></table>	-	-	-	-	-		
-	-	-							
-	-								
	0113145300								
	0113145300								
	accounts@freshlinesafety.com	RDA Reg No.	RDASR 0959						
12	Unique Industrial Solutions (Pvt) Ltd	Specilized Products / Brands	Business Reg. No						
	15, Uyankela rd, Panadura	<table border="1"><tr><td>Safety Shoes</td><td>-</td><td>-</td></tr><tr><td>-</td><td>-</td><td></td></tr></table>	Safety Shoes	-	-	-	-		
Safety Shoes	-	-							
-	-								
	0382222790								
	-								
	tenders@unique.lk	RDA Reg No.	RDASR 1023						

1.42 Others

1	Mahajana Hardware	Specilized Products / Brands	Business Reg. No	NCP0025						
	No.90, Main Street, Anuradhaoura	<table border="1"> <tr> <td>-</td> <td>-</td> <td>-</td> </tr> <tr> <td>-</td> <td>-</td> <td></td> </tr> </table>	-	-	-	-	-			
-	-	-								
-	-									
	0252223901									
	0252223902									
	nazeer.mahajana@gmail.com	RDA Reg No.	RDASR	0053						
2	Twin Clothing (Pvt) ltd	Specilized Products / Brands	Business Reg. No	PV114920						
	No.137/M, Colombo rd, Biyagama	<table border="1"> <tr> <td>T-shirts</td> <td>Caps</td> <td>Bags</td> </tr> <tr> <td>Hats</td> <td>-</td> <td></td> </tr> </table>	T-shirts	Caps	Bags	Hats	-			
T-shirts	Caps	Bags								
Hats	-									
	0112488502									
	0112487623									
	info@twinclothing.lk	RDA Reg No.	RDASR	0491						
3	Glan International	Specilized Products / Brands	Business Reg. No	W/208415						
	No.551, Mihindu Mw, Malabe	<table border="1"> <tr> <td>Sri Lanka Fundation</td> <td>WS&DB</td> <td>Canwin Hotels</td> </tr> <tr> <td>CEB</td> <td>municipal Council- Keshawa</td> <td></td> </tr> </table>	Sri Lanka Fundation	WS&DB	Canwin Hotels	CEB	municipal Council- Keshawa			
Sri Lanka Fundation	WS&DB	Canwin Hotels								
CEB	municipal Council- Keshawa									
	0113084763/0764600293									
	-									
	glan@glaninternational.com	RDA Reg No.	RDASR	0607						
4	T.D.R.Engineering and Construction	Specilized Products / Brands	Business Reg. No	3917						
	No.08, Good Shed Rd, Rathnapura	<table border="1"> <tr> <td>-</td> <td>-</td> <td>-</td> </tr> <tr> <td>-</td> <td>-</td> <td></td> </tr> </table>	-	-	-	-	-			
-	-	-								
-	-									
	0717850600									
	0452222118									
	tdengineeringc@gmail.com	RDA Reg No.	RDASR	0817						
5	Tharushi Decorators	Specilized Products / Brands	Business Reg. No							
	146/A, Nawala rd, Nugegoda	<table border="1"> <tr> <td>-</td> <td>-</td> <td>-</td> </tr> <tr> <td>-</td> <td>-</td> <td></td> </tr> </table>	-	-	-	-	-			
-	-	-								
-	-									
	0712303994/0714303994									
	0112817839									
	tharushidecorators@gmail.com	RDA Reg No.	RDASR	0784						

2.1 Auto Electrical & Maintenance Including AC Audio

1 Auto Air Con Systems



No.166, Obeysekarapura Rd,Rajagiriya



0112873480



0112863707



autoaircon60.@gmail.com

Specilized category / Brands

Business Reg. No

W/201009

-	-
-	-
-	-

RDA Reg No.

RDASR 0030

2 Browns Engineering and Construction (Pvt) Ltd



481, T.B.Jayah Mw, Colombo 10



0117644525



0117644548



bec@brownsinvestments.com

Specilized category / Brands

Business Reg. No

PV129313

-	-
-	-
-	-

RDA Reg No.

RDASR 0142

3 Sameera Auto Electricals



No.38/2, Old Rd, Nawinna, Maharagama



0714233093

-



sameera.electrical.auto@gmail.com

Specilized category / Brands

Business Reg. No

WC10212

-	-
-	-
-	-

RDA Reg No.

RDASR 0166

4 Toyotsu Lanka (Pvt) Ltd



No.359, Negombo rd, Wattala



0112904949



0112904945



info@toyotsu.lk

Specilized category / Brands

Business Reg. No

PV00225489

-	-
-	-
-	-

RDA Reg No.

RDASR 0227

5 Ceylon Motor Works Services (Pvt) Ltd



No.761/1, Kandy Rd, Kelaniya



0112917207



0112914834



info@ceylonmotorworks.com

Specilized category / Brands

Business Reg. No

PV5380

-	-
-	-
-	-

RDA Reg No.

RDASR 0236

6 Withma Auto AC and Ref Engineers



No.762, Main Road, Ethul Kotte, Kotte



0777651150



-



withautoac@gmail.com

Specilized category / Brands

Business Reg. No

























W87392

-	-
-	-
-	-

RDA Reg No.

RDASR 0243

2.2 Building Repairs, Masonry, Plumbing, Carpentry etc

1	Buildmarque Suppliers	Business Reg. No	WD 17649
	No.54/2, Galpoththa rd, Pore, Athurugiriya	Specilized category / Brands	
	0714538751/0778762434/0777118108	-	-
	-	-	-
	Buildmarque.suppliers@yahoo.com	RDA Reg No.	RDASR 0379
2	Rathna Engineering works	Business Reg. No	W.H.H.650
	No.27, Mathugama rd, Nebada	Specilized category / Brands	
	0771125740/0778552547	-	-
	-	-	-
	manojsamantha76@gmail.com	RDA Reg No.	RDASR 0543
3	Prime c.i.c.Corporation (Pvt) Ltd	Business Reg. No	PV241995
	No.112/1/2, Tea Estate rd, Ragama	Specilized category / Brands	
	0117568868/0771080300/0707040400	-	-
	-	-	-
	kumar.makavitage@gmail.com	RDA Reg No.	RDASR 0655
4	Sandamali Timber Depot	Business Reg. No	MPS/DS/Yanu/ 3850
	No.98, Ketapitiya, Menikdiwela	Specilized category / Brands	
	0772449472	Timber	-
	-	Furniture	-
	asith.kodi@gmail.com	-	-
		RDA Reg No.	RDASR 0696
5	T.D.R.Engineering and Construction	Business Reg. No	3917
	No.08, Good Shed Rd, Rathnapura	Specilized category / Brands	
	0717850600	-	-
	0452222118	-	-
	tdengineeringc@gmail.com	RDA Reg No.	RDASR 0817
6	W And C.N.Construction	Business Reg. No	-
	No.251/3, G.P.S. Junction, New Town, Medirigiriya	Specilized category / Brands	
	0711780277	-	-
	-	-	-
	nethranja@gmail.com	RDA Reg No.	RDASR 0869

2.2 Building Repairs, Masonry, Plumbing, Carpentry etc

7 **Dinithi Shakthi Construction (Pvt) Ltd** Business Reg. No PV90187

Specilized category / Brands

-	-
-	-
-	-

254/A, Horagala west, Padukka

0777720457
0112857693
sewminidinithi01@gmail.com

RDA Reg No. RDASR **0770**

8 **Lahiru Enterprise** Business Reg. No W53639

Specilized category / Brands

-	-
-	-
-	-

14/1, Second Lane, Subadrama rd, Nugegoda

0777812492
-
isisrasantha@gmail.com

RDA Reg No. RDASR **0936**

9 **Fentons Ltd** Business Reg. No PB334

Specilized category / Brands

























NEC	Gree
Bosch	-
Carrier	-

180, Deans rd, Colombo 10

























0112448518
0112448517
info@hayleysfentons.com

RDA Reg No. RDASR **1042**

2.3 Data, Voice Wiring/Networking

1	Browns Engineering and Construction (Pvt) Ltd  481, T.B.Jayah Mw, Colombo 10  0117644525  0117644548  bec@brownsinvestments.com	Specilized category / Brands <table border="1"> <tbody> <tr><td>-</td><td>-</td></tr> <tr><td>-</td><td>-</td></tr> <tr><td>-</td><td>-</td></tr> </tbody> </table>	-	-	-	-	-	-	Business Reg. No PV129313 RDA Reg No. RDASR 0142
-	-								
-	-								
-	-								
2	Rainbow Stationery & Electrical  No.476/1A, Maradana Rd, Colombo 10  0112674262  0112674262  -	Specilized category / Brands <table border="1"> <tbody> <tr><td>-</td><td>-</td></tr> <tr><td>-</td><td>-</td></tr> <tr><td>-</td><td>-</td></tr> </tbody> </table>	-	-	-	-	-	-	Business Reg. No WA55785 RDA Reg No. RDASR 0143
-	-								
-	-								
-	-								
3	Siegn Corporation (Pvt) Ltd  No.284/A, Galle Rd, Rawathawatta, Moratuwa  0112461462/0722303355  -  info@siegn.lk	Specilized category / Brands <table border="1"> <tbody> <tr><td>-</td><td>-</td></tr> <tr><td>-</td><td>-</td></tr> <tr><td>-</td><td>-</td></tr> </tbody> </table>	-	-	-	-	-	-	Business Reg. No PV00221095 RDA Reg No. RDASR 0148
-	-								
-	-								
-	-								
4	Dharmasiri Construction  No.14/A, Niralgama, Rathnapura  0717450408  -  darmasiriekanyake1968@gmail.com	Specilized category / Brands <table border="1"> <tbody> <tr><td>-</td><td>-</td></tr> <tr><td>-</td><td>-</td></tr> <tr><td>-</td><td>-</td></tr> </tbody> </table>	-	-	-	-	-	-	Business Reg. No R.P.02931 RDA Reg No. RDASR 0211
-	-								
-	-								
-	-								
5	Netsys Solutions (Pvt) Ltd  No.44A, Liyanage Mw, Vijithapura, Pelawatta, Battaramulla  0117376321/0112787300/0117699300  0112787500  info@netsys.lk	Specilized category / Brands <table border="1"> <tbody> <tr><td>Cisco</td><td>Ruckus</td></tr> <tr><td>Hewlett Packard Enterprise</td><td>Dell EMC</td></tr> <tr><td>Fortinet</td><td></td></tr> </tbody> </table>	Cisco	Ruckus	Hewlett Packard Enterprise	Dell EMC	Fortinet		Business Reg. No PV86501 RDA Reg No. RDASR 0281
Cisco	Ruckus								
Hewlett Packard Enterprise	Dell EMC								
Fortinet									
6	Advanced Micro Technology (Pvt) ltd  M 01, Lily Avenue, Robert Gunawardana Mw, Battaramulla  0112864225  0112883735  amtnet@slt.net.lk/hiran@amtsl.com	Specilized category / Brands <table border="1"> <tbody> <tr><td>Roger</td><td>-</td></tr> <tr><td>Automatic System</td><td>-</td></tr> <tr><td>-</td><td>-</td></tr> </tbody> </table>	Roger	-	Automatic System	-	-	-	Business Reg. No PV10779 RDA Reg No. RDASR 0515
Roger	-								
Automatic System	-								
-	-								

2.3 Data, Voice Wiring/Networking

7	Cool Air Company & Electronics	Business Reg. No	2/10/100/2021
	No.52, Market, Hakmana	Specilized category / Brands	
	0777183375	-	-
	-	-	-
	amilgunasekara@gmail.com	RDA Reg No.	RDASR 0915
8	Suprim Computers	Business Reg. No	R/Kuru/1367
	C.149/1B, Medawatta,Meneriwatta, Parakaduwa	Specilized category / Brands	
	0714831122/0719498123	-	-
	-	-	-
	bapfernandoo@gmail.com	RDA Reg No.	RDASR 0756
9	Runic Electronic Company	Business Reg. No	W20288
	26/B, Nugegoda rd, Papiliyana, Boralessgamuwa	Specilized category / Brands	
	0712736623	-	-
	-	-	-
	runicelctronic28@gmail.com	RDA Reg No.	RDASR 0921
10	D & P Electronics	Business Reg. No	86412
	14, 2nd Lane, Subadrama rd, Nugegoda	Specilized category / Brands	
	0771363583	-	-
	-	-	-
	dpelectronics19@gmail.com	RDA Reg No.	RDASR 0926
11	Assidua Technologies (Pvt) Ltd	Business Reg. No	PV84838
	No.149, Galle rd, Dehiwala	Specilized category / Brands	
	0112710088/0112710090	UPS	Stabilizers
	0112710089	UPS Batteries	solation Transformer
	tenders@assiduaonline.com/almeida@assiduaonline.com	Inverters	
		RDA Reg No.	RDASR 1026
12	Sumathi Information Technologies (Pvt) Ltd	Business Reg. No	PV417
	No.491, Galle rd, Colombo 03	Specilized category / Brands	
	0773887013/0115553311	Pix4D	-
	0115553312	TRD	-
	info@sit.lk	Rafael Advanced	
		RDA Reg No.	RDASR 1035

2.3 Data, Voice Wiring/Networking

13 **Fentons Ltd**



180, Deans rd, Colombo 10



0112448518



0112448517



info@hayleysfentons.com

Specilized category / Brands

Business
Reg. No

























PB334

NEC	Gree
Bosch	-
Carrier	

RDA Reg No.

RDASR **1042**

2.4 Electrical Wiring and Repairs

1	Siegn Corporation (Pvt) Ltd	Business Reg. No	PV00221095
		Specilized category / Brands	
		-	-
		-	-
		-	-
	No.284/A, Galle Rd, Rawathawatta, Moratuwa		
	0112461462/0722303355		
	-		
	info@siegn.lk	RDA Reg No.	RDASR 0148
2	Siegn Corporation (Pvt) Ltd	Business Reg. No	PV00221095
		Specilized category / Brands	
		-	-
		-	-
		-	-
	No.284/A, Galle Rd, Rawathawatta, Moratuwa		
	0112461462/0722303355		
	-		
	info@siegn.lk	RDA Reg No.	RDASR 0148
3	Dharmasiri Construction	Business Reg. No	R.P.02931
		Specilized category / Brands	
		-	-
		-	-
		-	-
	No.14/A, Niralgama, Rathnapura		
	0717450408		
	-		
	darmasiriekanyake1968@gmail.com	RDA Reg No.	RDASR 0211
4	Access International (Pvt) Ltd	Business Reg. No	PV5409
		Specilized category / Brands	
		-	-
		-	-
		-	-
	"Access Towers", 278, Union Place, Colombo 02		
	0112302302/0114741857-8		
	0112302333		
	ranils@access.lk	RDA Reg No.	RDASR 0229
5	Buildmarque Suppliers	Business Reg. No	WD 17649
		Specilized category / Brands	
		-	-
		-	-
		-	-
	No.54/2, Galpoththa rd, Pore, Athurugiriya		
	0714538751/0778762434/0777118108		
	-		
	Buildmarque.suppliers@yahoo.com	RDA Reg No.	RDASR 0379
6	Athugala Engineers (Pvt) Ltd	Business Reg. No	PV119901
		Specilized category / Brands	
		-	-
		-	-
		-	-
	Meduregedara, Dewataluwa, Kurunegala		
	0372065236		
	-		
	athugalaeng@gmail.com	RDA Reg No.	RDASR 0467

2.4 Electrical Wiring and Repairs

7 Diesel & Motor Engineering PLC



No.65, Jethamana Rd, Colombo 14



0112449797/0112338883



0112449080



dimo@dimolanka.com

Specilized category / Brands

-	-
-	-
-	-

Business
Reg. No

PQ146

RDA Reg No.

RDASR **0476**

8 D & P Electronics



14, 2nd Lane, Subadrama rd, Nugegoda



0771363583



-



dpelectronics19@gmail.com

Specilized category / Brands

-	-
-	-
-	-

Business
Reg. No

86412

RDA Reg No.

RDASR **0926**

9 Fentons Ltd



180, Deans rd, Colombo 10



0112448518



0112448517



info@hayleysfentons.com

Specilized category / Brands

NEC	Gree
Bosch	-
Carrier	-

Business
Reg. No

PB334

RDA Reg No.

RDASR **1042**

10 Mega Sine Electricals (Pvt) Ltd



No.398/32, Pragathi Mw, Wedagewatta Rd,
Magamma, Homagama



0112181245



0112181244



info@mselectricals.net

Specilized category / Brands

-	-
-	-
-	-

Business
Reg. No

PV00225412

RDA Reg No.

RDASR **1060**

2.5 Genarator Services & Maintenance

<p>1 Browns Engineering and Construction (Pvt) Ltd</p> <p>481, T.B.Jayah Mw, Colombo 10</p> <p>0117644525 0117644548 bec@brownsinvestments.com</p>	<p>Specilized category / Brands</p> <table border="1"> <tr><td>-</td><td>-</td></tr> <tr><td>-</td><td>-</td></tr> <tr><td>-</td><td>-</td></tr> </table>	-	-	-	-	-	-	<p>Business Reg. No PV129313</p> <p>RDA Reg No. RDASR 0142</p>
-	-							
-	-							
-	-							
<p>2 Nativeway (Pvt) Ltd</p> <p>No.549, Sri Sangaraja Mw, Colombo 10</p> <p>0112030730/0773370742 0112336802 tenders@nativeway.lk/info@nativeway.lk</p>	<p>Specilized category / Brands</p> <table border="1"> <tr><td>Tekson-Generators</td><td>FMTU-Generators</td></tr> <tr><td>Cooper- Generators</td><td>water Pumps</td></tr> <tr><td>Lutian- Generators</td><td></td></tr> </table>	Tekson-Generators	FMTU-Generators	Cooper- Generators	water Pumps	Lutian- Generators		<p>Business Reg. No PV1214</p> <p>RDA Reg No. RDASR 0187</p>
Tekson-Generators	FMTU-Generators							
Cooper- Generators	water Pumps							
Lutian- Generators								
<p>3 Buildmarque Suppliers</p> <p>No.54/2, Galpoththa rd, Pore, Athurugiriya</p> <p>0714538751/0778762434/0777118108 - Buildmarque.suppliers@yahoo.com</p>	<p>Specilized category / Brands</p> <table border="1"> <tr><td>-</td><td>-</td></tr> <tr><td>-</td><td>-</td></tr> <tr><td>-</td><td>-</td></tr> </table>	-	-	-	-	-	-	<p>Business Reg. No WD 17649</p> <p>RDA Reg No. RDASR 0379</p>
-	-							
-	-							
-	-							
<p>4 Joe Brothers</p> <p>No.09, Jayamaha Vihara Rd, Thotamuna, Matara</p> <p>0412235554/0714336510 - goebrotherspls@gmail.com</p>	<p>Specilized category / Brands</p> <table border="1"> <tr><td>-</td><td>-</td></tr> <tr><td>-</td><td>-</td></tr> <tr><td>-</td><td>-</td></tr> </table>	-	-	-	-	-	-	<p>Business Reg. No Ma/1/929</p> <p>RDA Reg No. RDASR 0667</p>
-	-							
-	-							
-	-							
<p>5 Metropolitan Technologies (Pvt) Ltd</p> <p>No.12, Magazine rd, Colombo 08</p> <p>0114700200 0114700267 salesmal@metropolitan.lk</p>	<p>Specilized category / Brands</p> <table border="1"> <tr><td>Chigo-Air Conditioners</td><td>Engineering- Gener</td></tr> <tr><td>Acer- Computers</td><td>lingbo RDC- Piplicator</td></tr> <tr><td>Printronix-Printers</td><td></td></tr> </table>	Chigo-Air Conditioners	Engineering- Gener	Acer- Computers	lingbo RDC- Piplicator	Printronix-Printers		<p>Business Reg. No Pr9395</p> <p>RDA Reg No. RDASR 0866</p>
Chigo-Air Conditioners	Engineering- Gener							
Acer- Computers	lingbo RDC- Piplicator							
Printronix-Printers								
<p>6 Brown & Company PLC</p> <p>No.34, Sir Mohamed Macan Markar Mw, Colombo 03</p> <p>0115063280 0112307377 procurement@brownsgroup.com</p>	<p>Specilized category / Brands</p> <table border="1"> <tr><td>-</td><td>-</td></tr> <tr><td>-</td><td>-</td></tr> <tr><td>-</td><td>-</td></tr> </table>	-	-	-	-	-	-	<p>Business Reg. No PQ25</p> <p>RDA Reg No. RDASR 0736</p>
-	-							
-	-							
-	-							

2.5 Genarator Services & Maintenance

United Tractor & Equipment (Pvt)

7 Ltd



No.683, Negombo Rd, Wattala, Mabile



0773457320/0114828267



0112931550/0112935573



sales@ute.lk/ranjana@ute.lk

Specilized category / Brands

Business Reg.
No

























PV2671

Caterpillar SARL	-
ESAB India Ltd	-
JAX Engineering Pvt L	

RDA Reg No.

RDASR 0882

2.6 Indoor AC Units Service and Maintenance

1	D.M.Auto Spare Spares (Pvt) Ltd	Business Reg. No	PV9356
	No.334/108, Main Street, Anuradhapura	Specilized category / Brands	
	0252223622	-	-
	-	-	-
	dmqutospares@gmail.com	RDA Reg No.	RDASR 0023
2	RDM Construction (PVT) Ltd	Business Reg. No	PV00211601
	No.278, Galle Rd, Gorakana, Keselwatta, Panadura	Specilized category / Brands	
	0718063500	-	-
	-	-	-
	ravi_chaminda@yahoo.com	RDA Reg No.	RDASR 0121
3	Browns Engineering and Construction (Pvt) Ltd	Business Reg. No	PV129313
	481, T.B.Jayah Mw, Colombo 10	Specilized category / Brands	
	0117644525	-	-
	0117644548	-	-
	bec@brownsinvestments.com	RDA Reg No.	RDASR 0142
4	Winway Engineering (Pvt) Ltd	Business Reg. No	PV00220738
	200/38/D2, William Jayasooriya Mw, Bandaragama Rd, Kesbewa	Specilized category / Brands	
	0112620522/0114304470	-	-
	0112620522	-	-
	winwayeng@gmail.com	RDA Reg No.	RDASR 0361
5	Buildmarque Suppliers	Business Reg. No	WD 17649
	No.54/2, Galpoththa rd, Pore, Athurugiriya	Specilized category / Brands	
	0714538751/0778762434/0777118108	-	-
	-	-	-
	Buildmarque.suppliers@yahoo.com	RDA Reg No.	RDASR 0379
6	New Tech Engineering and Trading (Pvt) Ltd	Business Reg. No	PV00208756
	No.85, Borala rd, Weligama	Specilized category / Brands	
	0772333382/0777712955	-	-
	-	-	-
	info.newtechengineering@gmail.com	RDA Reg No.	RDASR 0571

7 **Nec Technologies**



No.58, New Town, Rathnapura



0452228162



0452050877



82nectechnologies@gmail.com

Specilized category / Brands

Toner, Cartridge	Photocopy Machine
Ribben	Fax Machine
Computers, Laptops	

Business Reg. No. RPDS/ADM/RC/01/BRG/0270

RDA Reg No. RDASR 0603

8 **Rohan Ref Center**



No.14, Millenium Crest, Siri Dhammarathana Mw, Pamburana, Matara



0714073166/0412232777



-



rohanacref@gmail.com

Specilized category / Brands

-	-
-	-
-	-

Business Reg. No. Ma/1/4385

RDA Reg No. RDASR 0681

9 **Metropolitan Technologies (Pvt) Ltd**



No.12, Magazine rd, Colombo 08



0114700200



0114700267



salesmal@metropolitan.lk

Specilized category / Brands

Chigo-Air Conditioners	Engineering- Gener
Acer- Computers	lingbo RDC- Piplicator
Printronix-Printers	

Business Reg. No. Pr9395

RDA Reg No. RDASR 0866

10 **Brown & Company PLC**



No.34, Sir Mohamed Macan Markar Mw, Colombo 03



0115063280



0112307377



procurement@brownsgroup.com

Specilized category / Brands

-	-
-	-
-	-

Business Reg. No. PQ25

RDA Reg No. RDASR 0736

11 **Weligama Motors**



536/C, Amaragoda Rd, Hokandara



0728085620



0112776009



weligama.motorsh@gmail.com

Specilized category / Brands

-	-
-	-
-	-

Business Reg. No. W99226

RDA Reg No. RDASR 0875

12 **Saman Auto Electricals**



771/1, Pannipitiya rd, Thalawathugoda



0777474721



0112776000



saman721auto@gmail.com

Specilized category / Brands

-	-
-	-
-	-

Business Reg. No. W65363

RDA Reg No. RDASR 0879

2.7 Labour Contractors on Tinkering & Painting or Outsourced Works

1	Autotop Motoway (Pvt) Ltd	Business Reg. No	PV132158
	229/21, Old Kottawa rd, Navinna, Maharagama	Specilized category / Brands	
	011284942	-	-
	0112849412	-	-
	autotopmotowat@gmail.com	-	-
		RDA Reg No.	RDASR 0154
2	Riscar Auro Mobile	Business Reg. No	K/J2004
	No.102, Vihara Mw, Bellanwila, Boralesgamuwa	Specilized category / Brands	
	0777376801/0718915464/0112738900	-	-
	0112738900	-	-
	chandanagamage87@gmail.com	-	-
		RDA Reg No.	RDASR 0214
3	Soma Motors	Business Reg. No	WB214
	6/11, Samudradevi Mw, Ethul Kotte, Kotte	Specilized category / Brands	
	0727525292	-	-
	-	-	-
	chatu04@gmail.com	-	-
		RDA Reg No.	RDASR 0244
4	NB Auto Spa Services (Pvt) Ltd	Business Reg. No	PV00223045
	No.159/02, New Kandy Rd, Pillugala, Malabe	Specilized category / Brands	
	011241348/0777809148	-	-
	-	-	-
	capt.sampath@yahoo.com	-	-
		RDA Reg No.	RDASR 0370
5	Volga Motors	Business Reg. No	W12416
	No.159, Highlevel rd, Galawilawatta, Homagama	Specilized category / Brands	
	0112857379/0777307128	-	-
	-	-	-
	volgamotorssl@gmail.com	-	-
		RDA Reg No.	RDASR 0691
6	Dasa Motors Works	Business Reg. No	-
	No.89/1, Ramya Mw, Subuthipura, Battaramulla	Specilized category / Brands	
	0729236390	-	-
	-	-	-
	nadeekadrashani@gmail.com	-	-
		RDA Reg No.	RDASR 0695

2.7 Labour Contractors on Tinkering & Painting or Outsourced Works

7 Chandrasiri Motor Works



125, Rajagiriya rd rd, Rajagiriya



0112866975



0112879007



chandrasirimotorsra@gmail.com

Specilized category / Brands

Specilized category / Brands	Business Reg. No
-	-
-	-
-	-

Business Reg. No

WS8663

RDA Reg No.

RDASR

0703

8 Trust International Engineering Services (Pvt) Ltd



No.687/1/B, Yatihena, Waduwegama, Malwana, Biyagama



0112465631/0759848433



-



trusteng91@gmail.com

Specilized category / Brands

Specilized category / Brands	Business Reg. No
-	-
-	-
-	-

Business Reg. No

PV99086

RDA Reg No.

RDASR

0930

9 S.L.Motors



638/2, Thunadahena,Kprathota, Kaduwela



0112771152



0112771152



sllakshman22@gmail.com

Specilized category / Brands

Specilized category / Brands	Business Reg. No
-	-
-	-
-	-

Business Reg. No

























WD5442

RDA Reg No.

























RDASR

0940

























2.8 Maintenance & Repair - Engine Overhauls and Related Machine Works

1	D.M.Auto Spare Spares (Pvt) Ltd	Business Reg. No	PV9356						
	No.334/108, Main Street, Anuradhapura	Specilized category / Brands							
	0252223622	<table border="1"><tr><td>0</td></tr><tr><td>0</td></tr><tr><td>0</td></tr></table>	0	0	0	<table border="1"><tr><td>0</td></tr><tr><td>0</td></tr><tr><td>0</td></tr></table>	0	0	0
0									
0									
0									
0									
0									
0									
	-	RDA Reg No.							
	dmqutospares@gmail.com	RDASR 0023							
2	S.J.Motors	Business Reg. No	Wa96299						
	450/1/A, Rajasingha Mw, Udumulla, Mulleriyawa	Specilized category / Brands							
	0777549692	<table border="1"><tr><td>0</td></tr><tr><td>0</td></tr><tr><td>0</td></tr></table>	0	0	0	<table border="1"><tr><td>0</td></tr><tr><td>0</td></tr><tr><td>0</td></tr></table>	0	0	0
0									
0									
0									
0									
0									
0									
	0112741011	RDA Reg No.							
	sjmotorssl@gmail.com	RDASR 0037							
3	D.M.Auto Spare Spares (Pvt) Ltd	Business Reg. No	PV9356						
	No.334/108, Main Street, Anuradhapura	Specilized category / Brands							
	0252223622	<table border="1"><tr><td>0</td></tr><tr><td>0</td></tr><tr><td>0</td></tr></table>	0	0	0	<table border="1"><tr><td>0</td></tr><tr><td>0</td></tr><tr><td>0</td></tr></table>	0	0	0
0									
0									
0									
0									
0									
0									
	-	RDA Reg No.							
	dmqutospares@gmail.com	RDASR 0023							
4	Edirisinghe Brothers (Pvt) Ltd	Business Reg. No	PV8183						
	"Auto Court", No.567, Prince of Wales Avenue, Colombo 14	Specilized category / Brands							
	0112431808	<table border="1"><tr><td>0</td></tr><tr><td>0</td></tr><tr><td>0</td></tr></table>	0	0	0	<table border="1"><tr><td>0</td></tr><tr><td>0</td></tr><tr><td>0</td></tr></table>	0	0	0
0									
0									
0									
0									
0									
0									
	0112336223	RDA Reg No.							
	service@autocourt.net	RDASR 0049							
5	Ananda Motors	Business Reg. No	WC4799						
	61/1, Sigera Rd, Madiwela, Kotte	Specilized category / Brands							
	0444674275/0112799654	<table border="1"><tr><td>0</td></tr><tr><td>0</td></tr><tr><td>0</td></tr></table>	0	0	0	<table border="1"><tr><td>0</td></tr><tr><td>0</td></tr><tr><td>0</td></tr></table>	0	0	0
0									
0									
0									
0									
0									
0									
	-	RDA Reg No.							
	dinukanavod06@gmail.com	RDASR 0112							
6	Amal Diesel Motors	Business Reg. No	-						
	No.17, Kekunadura Rd, Meddawatta, Matara	Specilized category / Brands							
	0777276159/0412235122	<table border="1"><tr><td>0</td></tr><tr><td>0</td></tr><tr><td>0</td></tr></table>	0	0	0	<table border="1"><tr><td>0</td></tr><tr><td>0</td></tr><tr><td>0</td></tr></table>	0	0	0
0									
0									
0									
0									
0									
0									
	-	RDA Reg No.							
	amalmotorsmtr@gmail.com	RDASR 0123							

























2.8 Maintenance & Repair - Engine Overhauls and Related Machine Works

7	Autotop Motoway (Pvt) Ltd		Business Reg. No	PV132158					
		Specilized category / Brands							
	229/21, Old Kottawa rd, Navinna, Maharagama	<table border="1"><tr><td>0</td></tr><tr><td>0</td></tr><tr><td>0</td></tr></table>	0	0	0	<table border="1"><tr><td>0</td></tr><tr><td>0</td></tr></table>	0	0	
0									
0									
0									
0									
0									
	011284942								
	0112849412								
	autotopmotowat@gmail.com		RDA Reg No.	RDASR 0154					
8	Premadasa Motors		Business Reg. No	WD14534					
		Specilized category / Brands							
	947/2, J.C.Garden, Pannipitiya Rd, Battaramulla	<table border="1"><tr><td>0</td></tr><tr><td>0</td></tr><tr><td>0</td></tr></table>	0	0	0	<table border="1"><tr><td>0</td></tr><tr><td>0</td></tr></table>	0	0	
0									
0									
0									
0									
0									
	0772564805/0772879763								
	0112077922								
	deshani.premadasamptors@gmail.com		RDA Reg No.	RDASR 0168					
9	Matara Garage (Pvt) Ltd		Business Reg. No	PM8987					
		Specilized category / Brands							
	287/5, High Level Rd, Kirulapona, Colombo 05	<table border="1"><tr><td>0</td></tr><tr><td>0</td></tr><tr><td>0</td></tr></table>	0	0	0	<table border="1"><tr><td>0</td></tr><tr><td>0</td></tr></table>	0	0	
0									
0									
0									
0									
0									
	0112818040-41/0112818888/2812020								
	0112817735								
	mmgpvt@gmail.com		RDA Reg No.	RDASR 0223					
10	J.D.Rusiru Kavinda		Business Reg. No	WC21380					
		Specilized category / Brands							
	No.43/42, Walauwawatta Rd, Gangodawila, Nugegoda	<table border="1"><tr><td>0</td></tr><tr><td>0</td></tr><tr><td>0</td></tr></table>	0	0	0	<table border="1"><tr><td>0</td></tr><tr><td>0</td></tr></table>	0	0	
0									
0									
0									
0									
0									
	0717581834								
	-								
	samanaleemotorengineers@gmail.com		RDA Reg No.	RDASR 0111					
11	Onil Motors		Business Reg. No	WP2473					
		Specilized category / Brands							
	673/K, Kandawatta, Thalagama south, Battaramulla, 5th lane	<table border="1"><tr><td>0</td></tr><tr><td>0</td></tr><tr><td>0</td></tr></table>	0	0	0	<table border="1"><tr><td>0</td></tr><tr><td>0</td></tr></table>	0	0	
0									
0									
0									
0									
0									
	0112785991/0770556379								
	-								
	onilprasanna@gmail.com		RDA Reg No.	RDASR 0105					
12	Jayantha Motors and Fiber Glass		Business Reg. No	WP7021					
		Specilized category / Brands							
	No.50, Jaya Mw, Battaramulla	<table border="1"><tr><td>0</td></tr><tr><td>0</td></tr><tr><td>0</td></tr></table>	0	0	0	<table border="1"><tr><td>0</td></tr><tr><td>0</td></tr></table>	0	0	
0									
0									
0									
0									
0									
	0719171080								
	-								
	jayanthamotors2020@gmail.com		RDA Reg No.	RDASR 0273					

























2.8 Maintenance & Repair - Engine Overhauls and Related Machine Works

13	Karmart Engineers	Business Reg. No	WC8823					
	No.128, Madiwela Rd, Embuldeniya	Specilized category / Brands						
	0772678567/0712182425	<table border="1"><tr><td>0</td></tr><tr><td>0</td></tr><tr><td>0</td></tr></table>	0	0	0	<table border="1"><tr><td>0</td></tr><tr><td>0</td></tr></table>	0	0
0								
0								
0								
0								
0								
	-							
	karmart431@gmail.com	RDA Reg No.	RDASR 0274					
14	Neo Tech Motors & Service	Business Reg. No	W/206312					
	No.23/1/A,Main Street, Battaramulla	Specilized category / Brands						
	0112887998	<table border="1"><tr><td>0</td></tr><tr><td>0</td></tr><tr><td>0</td></tr></table>	0	0	0	<table border="1"><tr><td>0</td></tr><tr><td>0</td></tr></table>	0	0
0								
0								
0								
0								
0								
	-							
	neotechmotorslk@gmail.com	RDA Reg No.	RDASR 0275					
15	Winway Engineering (Pvt) Ltd	Business Reg. No	PV00220738					
	200/38/D2, William Jayasooriya Mw, Bandaragama Rd, Kesbewa	Specilized category / Brands						
	0112620522/0114304470	<table border="1"><tr><td>0</td></tr><tr><td>0</td></tr><tr><td>0</td></tr></table>	0	0	0	<table border="1"><tr><td>0</td></tr><tr><td>0</td></tr></table>	0	0
0								
0								
0								
0								
0								
	0112620522							
	winwayeng@gmail.com	RDA Reg No.	RDASR 0361					
16	Sishan Auto Repairs (Pvt) Ltd	Business Reg. No	PV74814					
	No.483/4, Main Street, Kaduwela	Specilized category / Brands						
	0112537571/0112539065	<table border="1"><tr><td>0</td></tr><tr><td>0</td></tr><tr><td>0</td></tr></table>	0	0	0	<table border="1"><tr><td>0</td></tr><tr><td>0</td></tr></table>	0	0
0								
0								
0								
0								
0								
	0112539067							
	sishanautorepair@gmail.com	RDA Reg No.	RDASR 0260					
17	Reliance Motor Works	Business Reg. No	-					
	No.506, New Tangalle Rd., Pallimulla, Matara	Specilized category / Brands						
	0713830640/0415679626	<table border="1"><tr><td>0</td></tr><tr><td>0</td></tr><tr><td>0</td></tr></table>	0	0	0	<table border="1"><tr><td>0</td></tr><tr><td>0</td></tr></table>	0	0
0								
0								
0								
0								
0								
	-							
	reliancemotorworks63@gmail.com	RDA Reg No.	RDASR 0258					
18	Asian Auto Tec Vision	Business Reg. No	-					
	437/6, Deema Highlevel Rd, Meegoda	Specilized category / Brands						
	0754345928/0764345928	<table border="1"><tr><td>0</td></tr><tr><td>0</td></tr><tr><td>0</td></tr></table>	0	0	0	<table border="1"><tr><td>0</td></tr><tr><td>0</td></tr></table>	0	0
0								
0								
0								
0								
0								
	-							
	suneth4646@gmail.com	RDA Reg No.	RDASR 0369					





















2.8 Maintenance & Repair - Engine Overhauls and Related Machine Works

19	NB Auto Spa Services (Pvt) Ltd	Business Reg. No	PV00223045					
	Specilized category / Brands							
	No.159/02, New Kandy Rd, Pillugala, Malabe	<table border="1"><tr><td>0</td></tr><tr><td>0</td></tr><tr><td>0</td></tr></table>	0	0	0	<table border="1"><tr><td>0</td></tr><tr><td>0</td></tr></table>	0	0
0								
0								
0								
0								
0								
	011241348/0777809148							
	-							
	capt.sampath@yahoo.com	RDA Reg No.	RDASR 0370					
20	Diesel & Motor Engineering PLC	Business Reg. No	PQ146					
	Specilized category / Brands							
	No.65, Jethamana Rd, Colombo 14	<table border="1"><tr><td>0</td></tr><tr><td>0</td></tr><tr><td>0</td></tr></table>	0	0	0	<table border="1"><tr><td>0</td></tr><tr><td>0</td></tr></table>	0	0
0								
0								
0								
0								
0								
	0112449797/0112338883							
	0112449080							
	dimo@dimolanka.com	RDA Reg No.	RDASR 0476					
21	Shan Motors	Business Reg. No	W/A81170					
	Specilized category / Brands							
	45/H, Cemetri Rd, Battaramulla	<table border="1"><tr><td>0</td></tr><tr><td>0</td></tr><tr><td>0</td></tr></table>	0	0	0	<table border="1"><tr><td>0</td></tr><tr><td>0</td></tr></table>	0	0
0								
0								
0								
0								
0								
	0773603373							
	-							
	prasanna741022@gmail.com	RDA Reg No.	RDASR 0481					
22	Kavinda Auto Service	Business Reg. No	MA/1/3933					
	Specilized category / Brands							
	4 Post, Yatiyana rd, Kekunadura	<table border="1"><tr><td>0</td></tr><tr><td>0</td></tr><tr><td>0</td></tr></table>	0	0	0	<table border="1"><tr><td>0</td></tr><tr><td>0</td></tr></table>	0	0
0								
0								
0								
0								
0								
	0777555377/0412264373							
	-							
	kavindmat@yahoo.com	RDA Reg No.	RDASR 0528					
23	Eksath Diesel Motors	Business Reg. No	A5675					
	Specilized category / Brands							
	No.45, Sir T.B.Panabokke Mw, Gampola	<table border="1"><tr><td>0</td></tr><tr><td>0</td></tr><tr><td>0</td></tr></table>	0	0	0	<table border="1"><tr><td>0</td></tr><tr><td>0</td></tr></table>	0	0
0								
0								
0								
0								
0								
	0814928164/0771952341							
	0814928164							
	sareen.d@hotmail.com	RDA Reg No.	RDASR 0586					
24	Augustine Motors (Pvt) Ltd	Business Reg. No	PV10064					
	Specilized category / Brands							
	No.57, Jayantha Weerasekara Mw, Colombo 10	<table border="1"><tr><td>0</td></tr><tr><td>0</td></tr><tr><td>0</td></tr></table>	0	0	0	<table border="1"><tr><td>0</td></tr><tr><td>0</td></tr></table>	0	0
0								
0								
0								
0								
0								
	0112459326							
	0112423573							
	augustinemotors1952@gmail.com	RDA Reg No.	RDASR 0663					

























2.8 Maintenance & Repair - Engine Overhauls and Related Machine Works

25	Joe Brothers		Business Reg. No	Ma/1/929					
		Specilized category / Brands							
	No.09, Jayamaha Vihara Rd, Thotamuna, Matara	<table border="1"><tr><td>0</td></tr><tr><td>0</td></tr><tr><td>0</td></tr></table>	0	0	0	<table border="1"><tr><td>0</td></tr><tr><td>0</td></tr></table>	0	0	
0									
0									
0									
0									
0									
	0412235554/0714336510								
	-								
	goebrotherspls@gmail.com		RDA Reg No.	RDASR 0667					
26	Bethmage Group		Business Reg. No	3/u/60/2017-05-17/30					
		Specilized category / Brands							
	No.04, Dammulla Junction, Dammulla, Beliatta	<table border="1"><tr><td>0</td></tr><tr><td>0</td></tr><tr><td>0</td></tr></table>	0	0	0	<table border="1"><tr><td>0</td></tr><tr><td>0</td></tr></table>	0	0	
0									
0									
0									
0									
0									
	0472243598/0716005952/0703647263								
	-								
	bethmage86@gmail.com		RDA Reg No.	RDASR 0673					
27	Volga Motors		Business Reg. No	W12416					
		Specilized category / Brands							
	No.159, Highlevel rd, Galawilawatta, Homagama	<table border="1"><tr><td>0</td></tr><tr><td>0</td></tr><tr><td>0</td></tr></table>	0	0	0	<table border="1"><tr><td>0</td></tr><tr><td>0</td></tr></table>	0	0	
0									
0									
0									
0									
0									
	0112857379/0777307128								
	-								
	volgamotorssl@gmail.com		RDA Reg No.	RDASR 0691					
28	Chandrasiri Motor Works		Business Reg. No	WS8663					
		Specilized category / Brands							
	125, Rajagiriya rd rd, Rajagiriya	<table border="1"><tr><td>0</td></tr><tr><td>0</td></tr><tr><td>0</td></tr></table>	0	0	0	<table border="1"><tr><td>0</td></tr><tr><td>0</td></tr></table>	0	0	
0									
0									
0									
0									
0									
	0112866975								
	0112879007								
	chandrasirimotorsra@gmail.com		RDA Reg No.	RDASR 0703					
29	Weligama Motors		Business Reg. No	W99226					
		Specilized category / Brands							
	536/C, Amaragoda Rd, Hokandara	<table border="1"><tr><td>0</td></tr><tr><td>0</td></tr><tr><td>0</td></tr></table>	0	0	0	<table border="1"><tr><td>0</td></tr><tr><td>0</td></tr></table>	0	0	
0									
0									
0									
0									
0									
	0728085620								
	0112776009								
	weligama.motorsh@gmail.com		RDA Reg No.	RDASR 0875					
30	Saman Auto Electricals		Business Reg. No	W65363					
		Specilized category / Brands							
	771/1, Pannipitiya rd, Thalawathugoda	<table border="1"><tr><td>0</td></tr><tr><td>0</td></tr><tr><td>0</td></tr></table>	0	0	0	<table border="1"><tr><td>0</td></tr><tr><td>0</td></tr></table>	0	0	
0									
0									
0									
0									
0									
	0777474721								
	0112776000								
	saman721auto@gmail.com		RDA Reg No.	RDASR 0879					

2.8 Maintenance & Repair - Engine Overhauls and Related Machine Works

31	United Tractor & Equipment (Pvt) Ltd	Business Reg. No	PV2671
	No.683, Negombo Rd, Wattala, Mabole	Specilized category / Brands	
	0773457320/0114828267	terpillar SARM	0
	0112931550/0112935573	ESAB India Ltd	0
	sales@ute.lk/ranjana@ute.lk	Engineering Pvt Ltd	
		RDA Reg No.	RDASR 0882
32	Saman Auto Electricals	Business Reg. No	W65363
	771/1, Pannipitiya rd, Thalawathugoda	Specilized category / Brands	
	0777474721		0
	0112776000		0
	saman721auto@gmail.com		0
		RDA Reg No.	RDASR 0879
33	Vindeev Auto (Pvt) Ltd	Business Reg. No	PV62014
	Highlaval rd, Kottawa, Pannipitiya	Specilized category / Brands	
	0113031710/0773172734		0
	0112838875		0
	vindeevauto@yahoo.com		0
		RDA Reg No.	RDASR 0917
34	S.L.Motors	Business Reg. No	WD5442
	638/2, Thunadahena,Kprathota, Kaduwela	Specilized category / Brands	
	0112771152		0
	0112771152		0
	sllakshman22@gmail.com		0
		RDA Reg No.	RDASR 0940
35	Vikasitha Enterprises (Pvt) Ltd	Business Reg. No	PV912/24/10/2007
	No.225, High Level rd, Galawilawatta, Homagama	Specilized category / Brands	
	0772518657		0
	0112748429		0
	sales.vikasitha@gmail.com		0
		RDA Reg No.	RDASR 0988

2.9 Maintenance & Repair - Injector Pumps

1	D.M.Auto Spare Spares (Pvt) Ltd	Business Reg. No PV9356
	No.334/108, Main Street, Anuradhapura	
	0252223622	
	-	
	dmqutospare@gmail.com	RDA Reg No. RDASR 0023
2	Edirisinghe Brothers (Pvt) Ltd	Business Reg. No PV8183
	"Auto Court", No.567, Prince of Wales Avenue, Colombo 14	
	0112431808	
	0112336223	
	service@autocourt.net	RDA Reg No. RDASR 0049
3	Diesel Center	Business Reg. No WJ1024
	155,Colombo Rd,Wewala Junction, Piliyandala	
	0112618854/0775469046	
	-	
	diksonperera1948@gmail.com	RDA Reg No. RDASR 0162
4	Toyotsu Lanka (Pvt) Ltd	Business Reg. No PV0022548 9
	No.359, Negombo rd, Wattala	
	0112904949	
	0112904945	
	info@toyotsu.lk	RDA Reg No. RDASR 0227
5	Diesel & Motor Engineering PLC	Business Reg. No PQ146
	No.65, Jethamana Rd, Colombo 14	
	0112449797/0112338883	
	0112449080	
	dimo@dimolanka.com	RDA Reg No. RDASR 0476
6	Saman Auto Electricals	Business Reg. No W65363
	771/1, Pannipitiya rd, Thalawathugoda	
	0777474721	
	0112776000	
	saman721auto@gmail.com	RDA Reg No. RDASR 0879

2.10 Maintenance of Tolling System

1 #N/A



#N/A



#N/A



#N/A



























#N/A

Specilized category / Brands Business Reg. No #N/A

























#N/A	#N/A
#N/A	#N/A
#N/A	

RDA Reg No. RDASR -

2.11 Motor Vehicle Oil Changes, Servicing and Interior Cleaning Works

1	Colonial Motors (Ceylon) Ltd	Business Reg. No	PB1086
	No.449, Negombo rd, Peliyagoda	Specilized category / Brands	
	0117699555	-	-
	0117449450	-	-
	info@mazdalanka.lk	-	-
		RDA Reg No.	RDASR 0020
2	D.M.Auto Spare Spares (Pvt) Ltd	Business Reg. No	PV9356
	No.334/108, Main Street, Anuradhapura	Specilized category / Brands	
	0252223622	-	-
	-	-	-
	dmqutospares@gmail.com	-	-
		RDA Reg No.	RDASR 0023
3	S & A Auto Clinic	Business Reg. No	W/100852
	67/B, Narahenpita Rd' Nawala	Specilized category / Brands	
	0112805481/0716676777	-	-
	0112805481	-	-
	sachith.ucsc@gmail.com	-	-
		RDA Reg No.	RDASR 0035
4	Millenium Auto Express (Pvt) Ltd	Business Reg. No	PV00214674
	No.298, Buthgamuwa Rd, Rajagiriya	Specilized category / Brands	
	0112075254	-	-
	-	-	-
	milleniumautoe7@gmail.com	-	-
		RDA Reg No.	RDASR 0057
5	Deepthi Filling & Service (Pvt) Ltd	Business Reg. No	PV9353
	Jayanthi Mw, Puththalam Rd, Anuradhapura	Specilized category / Brands	
	0252222516	-	-
	0252223934	-	-
	rameshag@yahoo.com	-	-
		RDA Reg No.	RDASR 0065
6	King's Men Auto Pvt Ltd	Business Reg. No	PV00234003
	01, Dewala Veediya, Badulla	Specilized category / Brands	
	0555272727	-	-
	0552232177	-	-
	shan@driveline.lk	-	-
		RDA Reg No.	RDASR 0070

2.11 Motor Vehicle Oil Changes, Servicing and Interior Cleaning Works

7	Nawinna Service Station	Business Reg. No	WC2999
	No.968/5, Wata Mw, Wijerama, Nugegoda	Specilized category / Brands	
	0773272537	-	-
	0112802304	-	-
	robinkapuruge@gmail.com	-	-
		RDA Reg No.	RDASR 0118
8	"Madara" Auto Service Center	Business Reg. No	G/2/1058
	Godakanda Rd, Karapitiya, Galle	Specilized category / Brands	
	0912241952	-	-
	0912241952	-	-
	madaraservicecentre@gmail.com	-	-
		RDA Reg No.	RDASR 0139
9	Autotop Motoway (Pvt) Ltd	Business Reg. No	PV132158
	229/21, Old Kottawa rd, Navinna, Maharagama	Specilized category / Brands	
	011284942	-	-
	0112849412	-	-
	autotopmotowat@gmail.com	-	-
		RDA Reg No.	RDASR 0154
10	Autoshine (Pvt) Ltd	Business Reg. No	PV20478
	174/1, Old Kesbewa Rd, Delkanda, Nugegoda	Specilized category / Brands	
	0115548648	-	-
	0112819809	-	-
	autoshine88@gmail.com	-	-
		RDA Reg No.	RDASR 0173
11	Saman Auto Service center (P.V.T.) L.T.D.	Business Reg. No	PV122341
	No.548/3, Debarawewa, Thissamaharama	Specilized category / Brands	
	0472239194	-	-
	-	-	-
	samanservicetissa@gmail.com	-	-
		RDA Reg No.	RDASR 0185
12	Monarchy Auto Service	Business Reg. No	112222
	Dambokka, Boyagane, Kurunegala	Specilized category / Brands	
	0374640640/0714777335/0777771335	-	-
	0372239499	-	-
	Kumonarchy@yahoo.com	-	-
		RDA Reg No.	RDASR 0203

2.11 Motor Vehicle Oil Changes, Servicing and Interior Cleaning Works

13 **Toyotsu Lanka (Pvt) Ltd** Business Reg. No PV00225489

Specilized category / Brands

-	-
-	-
-	-

No.359, Negombo rd, Wattala

0112904949
0112904945
info@toyotsu.lk

RDA Reg No. RDASR **0227**

14 **Ceylon Motor Works Services (Pvt) Ltd** Business Reg. No PV5380

Specilized category / Brands

-	-
-	-
-	-

No.761/1, Kandy Rd, Kelaniya

0112917207
0112914834
info@ceylonmotorworks.com

RDA Reg No. RDASR **0236**

15 **Neo Tech Motors & Service** Business Reg. No W/206312

Specilized category / Brands

-	-
-	-
-	-

No.23/1/A,Main Street, Battaramulla

0112887998
-
neotechmotorslk@gmail.com

RDA Reg No. RDASR **0275**

16 **Dharmasiri Tyre House (Pvt) Ltd** Business Reg. No PV3967

Specilized category / Brands

DTH SUPER DAG Tyre	NANDI Tubes
DTHHIGH RUN Tyre	BKT Tyre
DTH FLAPS	

No.35/7, Shop Place, Kaduruwela

0272223388/0716844179
0272227777
dhtyres@slt.lk/dthsuganth@gmail.com

RDA Reg No. RDASR **0353**

17 **New Acts Auto Engineers** Business Reg. No WDE000032

Specilized category / Brands

-	-
-	-
-	-

No.807/B/2, Kandawatta Rd, Pelawatta, Battaramulla

0770125005/0112824444
-
gemunub@yahoo.com

RDA Reg No. RDASR **0363**

18 **Matin Super Service** Business Reg. No 3/7/415/2021/-11-11/31

Specilized category / Brands

























-	-
-	-
-	-

Bedigama, Witharandeniya

0774604149
-
1985nihal@gmail.com

RDA Reg No. RDASR **0385**

2.11 Motor Vehicle Oil Changes, Servicing and Interior Cleaning Works

19	Auto Care Center	Business Reg. No	M/1/2937
	Specilized category / Brands		
	Akuressa Road, Hittatiya, Matara	-	-
	0412228297/ 0414922388	-	-
	-		
	rajithuluwita@yahoo.com	RDA Reg No.	RDASR 0411
20	Diesel & Motor Engineering PLC	Business Reg. No	PQ146
	Specilized category / Brands		
	No.65, Jethamana Rd, Colombo 14	-	-
	0112449797/0112338883	-	-
	0112449080		
	dimo@dimolanka.com	RDA Reg No.	RDASR 0476
21	Kavinda Auto Service	Business Reg. No	MA/1/3933
	Specilized category / Brands		
	4 Post, Yatiyana rd, Kekunadura	-	-
	0777555377/0412264373	-	-
	-		
	kavindmat@yahoo.com	RDA Reg No.	RDASR 0528
22	Kleen Hub Service	Business Reg. No	POL/TKD/ESD/0 2/02/5017
	Specilized category / Brands		
	24 Post, Bendhi Wewa, Jayanthipura, Polonnaruwa	-	-
	0272225477	-	-
	0272225530		
	-	RDA Reg No.	RDASR 0535
23	Binara Auto Services	Business Reg. No	NCP/TK/1/4/137 6
	Specilized category / Brands		
	No.40/1, Palugasdamana, Polonnaruwa	-	-
	0777445816	-	-
	0272222281		
	gaminihettiarachchi50@gmail.com	RDA Reg No.	RDASR 0553
24	Monaragala Motors (PVT) Ltd	Business Reg. No	PV00247282
	Specilized category / Brands		
	Kumara Dola Rd, Monaragala	-	-
	0552276757	-	-
	0552276757		
	monaragalamotors1@gmail.com	RDA Reg No.	RDASR 0554

2.11 Motor Vehicle Oil Changes, Servicing and Interior Cleaning Works

25 Pulasthi Autocare & Springs Services Business Reg. NCP/TK/1/4/429 No 1

Specilized category / Brands

-	-
-	-
-	-

No.102/3, Swarajyanthi Mw, 4th Cannel, Kaduruwela, Polonnaruwa

0272225565/0775022199/0719306453

-

pulasthiautocare@gmail.com RDA Reg No. RDASR **0581**

26 Development Construction & Mechinery Authority Business Reg. 2009 no.02 No

Specilized category / Brands

-	-
-	-
-	-

Paradise, Kuruvita

0452262687

0452264199

admin@decma.sg.gov.lk/info@decma.sg.gov.lk RDA Reg No. RDASR **0659**

27 Saliya Motors Business Reg. 20/0623 No

Specilized category / Brands

-	-
-	-
-	-

300/1, Kandy Rd, Millawa, Kurunegala

0372222447

0372222893

saliyamotors7@gmail.com RDA Reg No. RDASR **0827**

28 Auto Glance (Pvt) Ltd Business Reg. PV121356 No

Specilized category / Brands

-	-
-	-
-	-

No.305, Kaduwela rd, Koswatta, Battaramulla

0112887999

-

autoglancesl@gmail.com RDA Reg No. RDASR **0739**

29 New Clean Spot Service Business Reg. KT/DS/PR/70 No

Specilized category / Brands

-	-
-	-
-	-

Main Street, Maligaikadu, Karitivu

0672222768

-

mraanshaf768@gmail.com RDA Reg No. RDASR **0800**

30 Mount House Holdings Business Reg. Pro/40/R/R/0139 No 0

Specilized category / Brands

-	-
-	-
-	-

No.2/8A Survey Bungalow rd, Collins Cresent, Muwagama, Rathnapura

0452400400

0452228330

lakpawal@yahoo.com RDA Reg No. RDASR **0957**

2.11 Motor Vehicle Oil Changes, Servicing and Interior Cleaning Works

31 **Rashmi Auto service**

Business Reg. No 5250



"Rashmi", Poramadulla, Rikillagaskada

Specilized category / Brands

-	-
-	-
-	-



0773229971



-



























rashmi.mudannayaka95@gmail.com

























RDA Reg No.

RDASR 1038

























2.12 Office Cleaning

1	Spick and Span	Business Reg. No	-
	Specilized category / Brands		
	No.147, Sandhu, Siripura, Oruwala, Athurugiriya		
	0114968720/0723334786/0713568462		
	-		
	spick.a.span.7@gmail.com	RDA Reg No.	RDASR 0044
2	Gamini Traders Y.A.P.(Pvt) Ltd	Business Reg. No	PV00210107
	Specilized category / Brands		
	No.39/A, Avissawella Rd, Ranala		
	0114294005		
	0117460773		
	heshantraders@gaminigroup.lk	RDA Reg No.	RDASR 0087
3	Abans Environmental Services (Pvt) Ltd	Business Reg. No	PV8796
	Specilized category / Brands		
	No.141, Kirola Rd, Colombo 05		
	0117717777		
	0112369555		
	info@abansiss.com	RDA Reg No.	RDASR 0115
4	Jayashine Cleaning Service	Business Reg. No	WD2128
	Specilized category / Brands		
	No.301/B,Sathaya Mw, Athurugiriya		
	0112193536/0714270168		
	-		
	jayashinecc@gmail.com	RDA Reg No.	RDASR 0120
5	Micro Channel Lanka (Pvt) Ltd	Business Reg. No	DS/MNC/B R/764
	Specilized category / Brands		
	No.165D, New Kalmunai, Batticaloa		
	0762339997/0773201786/0777710086/0765788774		
	0652224646		
	info@mclpvt.lk	RDA Reg No.	RDASR 0261
6	Pioneer Cleaning Service (Pvt) Ltd	Business Reg. No	PV77362
	Specilized category / Brands		
	No.75, Awissawella rd,Mahabuthgamuwa, Angoda		
	0112549091		
	0112549992		
	info@pioneer.lk	RDA Reg No.	RDASR 0842

























2.13 Office Renovation (Aluminium Partitioning, Interior & Related Works)

1	RDM Construction (PVT) Ltd	Business Reg. No PV00211601
	No.278, Galle Rd, Gorakana, Keselwatta, Panadura	
	0718063500	
	-	
	ravi_chaminda@yahoo.com	
	Specilized category / Brands	
	-	-
	-	-
	-	-
	RDA Reg No.	RDASR 0121
2	New Interiors (Pvt) Ltd	Business Reg. No PV17473
	No.53/A, Kossinnawatta, Katuwawala, Boralesgamuwa	
	0117388133/5	
	0114303636	
	sales@newint.co	
	Specilized category / Brands	
	-	-
	-	-
	-	-
	RDA Reg No.	RDASR 0259
3	T.D.R.Engineering and Construction	Business Reg. No 3917
	No.08, Good Shed Rd, Rathnapura	
	0717850600	
	0452222118	
	tdengineeringc@gmail.com	
	Specilized category / Brands	
	-	-
	-	-
	-	-
	RDA Reg No.	RDASR 0817
4	SAW Engineering (Pvt) ltd	Business Reg. No PV9735
	No.52, Makola North, Makola	
	0112908366	
	0112908376	
	info@sawengineering.com	
	Specilized category / Brands	
	-	-
	-	-
	-	-
	RDA Reg No.	RDASR 0876
5	Leema Creations (Pvt) ltd	Business Reg. No PV13699
	No.112/2, H.Sri Nissanka Mw, (Maya Avenue), Colombo08	
	0112422875	
	0112587346	
	sales@leema.lk	
	Specilized category / Brands	
	-	-
	-	-
	-	-
	RDA Reg No.	RDASR 0905
6	New Southern Enterprises	Business Reg. No 91364
	85/C, Namal Uyana, Walpola, angoda	
	0715375116	
	-	
	anilgunasekara	
	Specilized category / Brands	
	-	-
	-	-
	-	-
	RDA Reg No.	RDASR 0920

2.14 Photographic Processing & Provide Identity Cards

1	Selacine Television Institute	Business Reg. No	-
	No.224, Baudhaloka Mw, Colombo 07	Specilized category / Brands	
	0112058227/0777668808		
	0112058229		
	selacine@gmail.com	RDA Reg No.	RDASR 0174
2	Tele- Pix Technologies (Pvt) Ltd	Business Reg. No	PV3755
	No.185, Peradeniya Rd, Kandy	Specilized category / Brands	
	0812202132/0777883990		
	0812204333		
	telepix.kandy@gmail.com	RDA Reg No.	RDASR 0392
3	C.S.Enterprises	Business Reg. No	NCP001672
	No.414/1, Godage Mw, Anuradhapura	Specilized category / Brands	
	0718723000/0254580628	ID Card Printer	-
	0252227147		
	cseenterprises18@gmail.com	RDA Reg No.	RDASR 0558
4	ADL Digi House (Pvt) Ltd	Business Reg. No	PV79776
	No.70/01/25, 1st Floor, YMBA Complex, Borella, Colombo 08	Specilized category / Brands	
	0112687683/0112687456/0772920945		
	0112687456		
	dighouse@sltnet.lk	RDA Reg No.	RDASR 0617
5	Prime c.i.c.Corporation (Pvt) Ltd	Business Reg. No	PV241995
	No.112/1/2, Tea Estate rd, Ragama	Specilized category / Brands	
	0117568868/0771080300/0707040400		
	-		
	kumar.makavitage@gmail.com	RDA Reg No.	RDASR 0655
6	T.D.R.Engineering and Construction	Business Reg. No	3917
	No.08, Good Shed Rd, Rathnapura	Specilized category / Brands	
	0717850600		
	0452222118		
	tdengineeringc@gmail.com	RDA Reg No.	RDASR 0817

2.15 Printing Works

1	Printec Establishment (Pvt) Ltd	Business Reg. No. PV63386						
	No.52/1, Ekwatta rd, Mirihana, Nugegoda	Specilized category / Brands						
	0112815816	<table border="1"><tr><td>-</td><td>-</td></tr><tr><td>-</td><td>-</td></tr><tr><td>-</td><td>-</td></tr></table>	-	-	-	-	-	-
-	-							
-	-							
-	-							
	-							
	salesprintec@gmail.com	RDA Reg No. RDASR 0007						
2	Sampath Printing Industries	Business Reg. Mps/DS/YN/1 No 26						
	No.380, Kandy Rd, Kadugannawa	Specilized category / Brands						
	0812571891	<table border="1"><tr><td>-</td><td>-</td></tr><tr><td>-</td><td>-</td></tr><tr><td>-</td><td>-</td></tr></table>	-	-	-	-	-	-
-	-							
-	-							
-	-							
	0812571891							
	sampathpri6@gmail.com	RDA Reg No. RDASR 0012						
3	Imashi Prakashana	Business Reg. No. w69279						
	96A, Wanatha Rd, Gangodawila, Nugegoda	Specilized category / Brands						
	0112803300/0115556223	<table border="1"><tr><td>-</td><td>-</td></tr><tr><td>-</td><td>-</td></tr><tr><td>-</td><td>-</td></tr></table>	-	-	-	-	-	-
-	-							
-	-							
-	-							
	0112801296							
	info@imashipublications.lk	RDA Reg No. RDASR 0043						
4	Nippon Graphics (Pvt) Ltd	Business Reg. No. PV11501						
	No.278, Galle Rd, Gorakana, Keselwatta, Panadura	Specilized category / Brands						
	0114211573	<table border="1"><tr><td>-</td><td>-</td></tr><tr><td>-</td><td>-</td></tr><tr><td>-</td><td>-</td></tr></table>	-	-	-	-	-	-
-	-							
-	-							
-	-							
	0382297361							
	nippongrap2@gmail.com	RDA Reg No. RDASR 0046						
5	New Asiri Printers	Business Reg. No. WC2100						
	12A, Waraketiya Rd, Maharagama	Specilized category / Brands						
	0777552062	<table border="1"><tr><td>-</td><td>-</td></tr><tr><td>-</td><td>-</td></tr><tr><td>-</td><td>-</td></tr></table>	-	-	-	-	-	-
-	-							
-	-							
-	-							
	0112844370							
	asiriprinters@gmail.com	RDA Reg No. RDASR 0047						
6	S.B.Printers (Pvt) Ltd	Business Reg. No. PV6485						
	No.441/3, 03rd Kurana, Colombord, Negombo	Specilized category / Brands						
	0312222069	<table border="1"><tr><td>-</td><td>-</td></tr><tr><td>-</td><td>-</td></tr><tr><td>-</td><td>-</td></tr></table>	-	-	-	-	-	-
-	-							
-	-							
-	-							
	0312228926							
	sbprinters@sltnet.lk	RDA Reg No. RDASR 0075						

2.15 Printing Works

7 **Nillwan Graphics** Business Reg. No W81573

Specilized category / Brands

-	-
-	-
-	-

No.73, Cotta Garden 's, Cotta Rd,
Borella

0112678966

-

nillwanlk@yahoo.com

RDA Reg No. RDASR **0104**

8 **Diaweb E Forms (Pvt) ltd** Business Reg. No PV64385

Specilized category / Brands

-	-
-	-
-	-

276/B, Dewamiththa Place, Mabima,
Heiyanthuduwa

0112082004

0112082006

dweforms@yahoo.com

RDA Reg No. RDASR **0109**

9 **Ravindra KRS Advertising Services (Pvt) Ltd** Business Reg. No PV14685

Specilized category / Brands

-	-
-	-
-	-

No.40, Biyagama Rd, Pethiyagoda,
Kelaniya

0112912270

0112915927

accounts@krs.lk

RDA Reg No. RDASR **0164**

10 **Selacine Television Institute** Business Reg. No -

Specilized category / Brands

-	-
-	-
-	-

No.224, Bauddhaloka Mw, Colombo
07

0112058227/0777668808

0112058229

selacine@gmail.com

RDA Reg No. RDASR **0174**

11 **ADTract (Pvt) Ltd** Business Reg. No PV00210168

Specilized category / Brands

-	-
-	-
-	-

No.87/7/1, Pahala imbulgoda,
Imbulgoda

0764509492/0114473307

-

adtract.action@gmail.com

RDA Reg No. RDASR **0191**

12 **K.S.U.Graphic (Pvt) Ltd** Business Reg. No PV20291

Specilized category / Brands

-	-
-	-
-	-

No.510, Rajagiriya rd, Rajagiriya

0112884701/074035595

-

ksugraphic@yahoo.com/ksugraphicpvt@gmail.com

RDA Reg No. RDASR **0422**

2.15 Printing Works

13 Ceylon Business Appliances (Pvt) Ltd



No.112, Reid Avenue, Colombo 04



0117845300



0112503121



sales@cba.lk

Specilized category / Brands

Business Reg. No PV791

Densimeters	-
Note Counters	-
-	-

RDA Reg No. RDASR 0451

14 Image Makers (Pvt) Ltd



578/1, Colombo rd,Nawanagaraya, Rathnapura



0452223626



-



imagemakers.lk@gmail.com

Specilized category / Brands

Business Reg. No PV90135

-	-
-	-
-	-

RDA Reg No. RDASR 0518

15 Ceylon Printers PLC



No.20, Sir Chittampala A. Gardiner Mw, Colombo02



0112434161-3



0112434147



ceylonprinters01@gmail.com

Specilized category / Brands

Business Reg. No PQ150

-	-
-	-
-	-

RDA Reg No. RDASR 0633

16 Development Construction & Mechinery Authority



Paradise, Kuruvita



0452262687



0452264199



admin@decma.sg.gov.lk/info@decma.sg.gov.lk

Specilized category / Brands

Business Reg. No 2009 no.02

-	-
-	-
-	-

RDA Reg No. RDASR 0659

17 Print and Print Grafics (Pvt) Ltd



No.6, Sri Bodhoraja Mw, Maligawatta, Colombo 10



0112687870/0112679011



0112670524



printgrapic2@gmail.com

Specilized category / Brands

Business Reg. No PV21779

-	-
-	-
-	-

RDA Reg No. RDASR 0711

18 Metropolitan Technologies (Pvt) Ltd



No.12, Magazine rd, Colombo 08



0114700200



0114700267



salesmal@metropolitan.lk

Specilized category / Brands

Business Reg. No Pr9395

Chigo-Air Conditioners	er Engineering- Gener
Acer- Computers	ningbo RDC- Piplicator
Printronix-Printers	

RDA Reg No. RDASR 0866

2.15 Printing Works

19 **E.P.A.Advertising (Pvt) Ltd**



No.185, Kalapaluwawa Rd, Koswatta,
Battaramulla



0112790771



0112790766



epaadvertisingacc1@gmail.com

Specilized category / Brands

Specilized category / Brands	Business Reg. No
-	-
-	-
-	-

Business Reg. No PV109810

RDA Reg No. RDASR 0939

20 **Narah Computer Foems**



309/4C, Negombo rd, Welisara



0112245700-888



0112245900/0112230061



narahncf@gmail.com

Specilized category / Brands

Specilized category / Brands	Business Reg. No
-	-
-	-
-	-

Business Reg. No WA31987

RDA Reg No. RDASR 0950

2.16 Rebuilding of Tyres

1 **Golden Wing Lanka International (Pvt) Ltd** Business Reg. No. PV98876

Specilized category / Brands

-	-
-	-
-	-

No.151, Highlevel rd, Pannipitiya

0112838384/0777399835

0112838384

dckgayan@gmail.com

RDA Reg No. RDASR **0283**

2 **Dulanka International (Pvt) Ltd** Business Reg. No. PV18510

Specilized category / Brands

-	-
-	-
-	-

ST George Estate, Yatadola, Mathugama

0382241216/0772352677

0382245100

dulankainternational@gmail.com

RDA Reg No. RDASR **0445**

3 **K.D.K. Tyre Service** Business Reg. No. W/GG/9/174

Specilized category / Brands

-	-
-	-
-	-

Near the Clock Tower, Athura, Bulathsinhala

0776067734

-

kdktyre@gmail.com

RDA Reg No. RDASR **0819**

2.17 Repairs And Maintenance of Electrical Equipment

1 **Browns Engineering and Construction (Pvt) Ltd** Business Reg. No. PV129313

Specilized category / Brands

-	-
-	-
-	-

481, T.B.Jayah Mw, Colombo 10

0117644525

0117644548

bec@brownsinvestments.com

RDA Reg No. RDASR **0142**

2 **Access International (Pvt) Ltd** Business Reg. No. PV5409

Specilized category / Brands

-	-
-	-
-	-

"Access Towers", 278, Union Place, Colombo 02

0112302302/0114741857-8

0112302333

ranils@access.lk

RDA Reg No. RDASR **0229**

3 **Volga Motors** Business Reg. No. W12416

Specilized category / Brands

-	-
-	-
-	-

No.159, Highlevel rd, Galawilawatta, Homagama

0112857379/0777307128

-

volgamotorssl@gmail.com

RDA Reg No. RDASR **0691**

4 **Metropolitan Technologies (Pvt) Ltd** Business Reg. No. Pr9395

Specilized category / Brands

Chigo-Air Conditioners	ser Engineering- Gener
Acer- Computers	lingbo RDC- Piplicator
Printronix-Printers	

No.12, Magazine rd, Colombo 08

























0114700200

0114700267

























salesmal@metropolitan.lk

RDA Reg No. RDASR **0866**

2.18 Repairs of Components of Motor Vehicles

1	D.M.Auto Spare Spares (Pvt) Ltd	Business Reg. No	PV9356
	Specilized category / Brands		
	No.334/108, Main Street, Anuradhapura	-	-
	0252223622	-	-
	-		
	dmqutospares@gmail.com	RDA Reg No.	RDASR 0023
2	S.J.Motors	Business Reg. No	Wa96299
	Specilized category / Brands		
	450/1/A, Rajasingha Mw, Udumulla, Mulleriyawa	-	-
	0777549692	-	-
	0112741011		
	sjmotorssl@gmail.com	RDA Reg No.	RDASR 0037
3	Onil Motors	Business Reg. No	WP2473
	Specilized category / Brands		
	673/K, Kandawatta, Thalangama south, Battaramulla, 5th lane	-	-
	0112785991/0770556379	-	-
	-		
	onilprasanna@gmail.com	RDA Reg No.	RDASR 0105
4	RDM Construction (PVT) Ltd	Business Reg. No	PV00211601
	Specilized category / Brands		
	No.278, Galle Rd, Gorakana, Keselwatta, Panadura	-	-
	0718063500	-	-
	-		
	ravi_chaminda@yahoo.com	RDA Reg No.	RDASR 0121
5	Autotop Motoway (Pvt) Ltd	Business Reg. No	PV132158
	Specilized category / Brands		
	229/21, Old Kottawa rd, Navinna, Maharagama	-	-
	011284942	-	-
	0112849412		
	autotopmotowat@gmail.com	RDA Reg No.	RDASR 0154
6	Ceylon Motor Works Services (Pvt) Ltd	Business Reg. No	PV5380
	Specilized category / Brands		
	No.761/1, Kandy Rd, Kelaniya	-	-
	0112917207	-	-
	0112914834		
	info@ceylonmotorworks.com	RDA Reg No.	RDASR 0236

2.18 Repairs of Components of Motor Vehicles

7	Get2 Auto Parts House	Business Reg. No	W66692
	No.233/A, Darley Rd, Colombo 10	Specilized category / Brands	
	0773358789/0117200703	-	-
	-	-	-
	jjajithtwelve@gmail.com	RDA Reg No.	RDASR 0291
8	New Acts Auto Engineers	Business Reg. No	WDE000032
	No.807/B/2, Kandawatta Rd, Pelawatta, Battaramulla	Specilized category / Brands	
	0770125005/0112824444	-	-
	-	-	-
	gemunub@yahoo.com	RDA Reg No.	RDASR 0363
9	Asian Auto Tec Vision	Business Reg. No	-
	437/6, Deema Highlevel Rd, Meegoda	Specilized category / Brands	
	0754345928/0764345928	-	-
	-	-	-
	suneth4646@gmail.com	RDA Reg No.	RDASR 0369
10	NB Auto Spa Services (Pvt) Ltd	Business Reg. No	PV00223045
	No.159/02, New Kandy Rd, Pillugala, Malabe	Specilized category / Brands	
	011241348/0777809148	-	-
	-	-	-
	capt.sampath@yahoo.com	RDA Reg No.	RDASR 0370
11	Diesel & Motor Engineering PLC	Business Reg. No	PQ146
	No.65, Jethamana Rd, Colombo 14	Specilized category / Brands	
	0112449797/0112338883	-	-
	0112449080	-	-
	dimo@dimolanka.com	RDA Reg No.	RDASR 0476
12	Kavinda Auto Service	Business Reg. No	MA/1/3933
	4 Post, Yatiyana rd, Kekunadura	Specilized category / Brands	
	0777555377/0412264373	-	-
	-	-	-
	kavindmat@yahoo.com	RDA Reg No.	RDASR 0528

2.18 Repairs of Components of Motor Vehicles

13 **Monaragala Motors (PVT) Ltd** Business Reg. No PV00247282

Specilized category / Brands

-	-
-	-
-	-

 Kumara Dola Rd, Monaragala

 0552276757

 0552276757

 monaralamotors1@gmail.com

RDA Reg No. **RDASR 0554**

14 **Development Construction & Mechinery Authority** Business Reg. No 2009 no.02

Specilized category / Brands

-	-
-	-
-	-

 Paradise, Kuruvita

 0452262687

 0452264199

 admin@decma.sg.gov.lk/info@decma.sg.gov.lk

RDA Reg No. **RDASR 0659**

15 **New Palitha Auto Engineers** Business Reg. No -

Specilized category / Brands

-	-
-	-
-	-

 5th Cross Rd, Weragampita, Matara

 0412234922/0776902599

 0412234922

 newpalithaautoengineers1@gmail.com

RDA Reg No. **RDASR 0676**

16 **Auto Glance (Pvt) Ltd** Business Reg. No PV121356

Specilized category / Brands

-	-
-	-
-	-

 No.305, Kaduwela rd, Koswatta, Battaramulla

 0112887999

 -

 autoglancesl@gmail.com

RDA Reg No. **RDASR 0739**

17 **Weligama Motors** Business Reg. No W99226

Specilized category / Brands

-	-
-	-
-	-

 536/C, Amaragoda Rd, Hokandara

 0728085620

 0112776009

 weligama.motorsh@gmail.com

RDA Reg No. **RDASR 0875**

18 **Vindeev Auto (Pvt) Ltd** Business Reg. No PV62014

Specilized category / Brands

-	-
-	-
-	-

 Highlaval rd, Kottawa, Pannipitiya

 0113031710/0773172734

 0112838875

 vindeevauto@yahoo.com

RDA Reg No. **RDASR 0917**

2.18 Repairs of Components of Motor Vehicles

19 **Vikasitha Enterprises (Pvt) Ltd**

Business Reg. No. PV912/24/10/20
07



No.225, High Level rd, Galawilawatta,
Homagama

Specilized category / Brands

-	-
-	-
-	-



0772518657



0112748429



sales.vikasitha@gmail.com

RDA Reg No.

RDASR **0988**

20

Delta Motor Engineers

Business Reg. No. W/C 6738



272/B, Hokandara Rd, Thalawathugoda

Specilized category / Brands

-	-
-	-
-	-



0112773723



0112773723



























sunithravi6@gmail.com

























RDA Reg No.

RDASR **1001**

2.19 Repairs of Computers Services on Hardware

1	Base Hp (Pvt) Ltd	Specilized category / Brands	Business Reg. No	PV62948
	36A, Gower Street, Colombo 05	-	-	
	0115746800	-	-	
	0112506633	-	-	
	info@basehp.lk/gayans@basehp.lk			RDA Reg No. RDASR 0041
2	VS Information Systems (Pvt) Ltd	Specilized category / Brands	Business Reg. No	PV66809
	No.07, suleiman Terrace, Colombo 05	-	-	
	0112038500	-	-	
	0112555805	-	-	
	marketingsupport@vsis.lk/sales@vsis.lk			RDA Reg No. RDASR 0067
3	ASTP Tec Pvt Ltd	Specilized category / Brands	Business Reg. No	PV75727
	No.49, 1st Cross Street, Jaffna	Dell	-	
	0212222674	HP	-	
	0212228147	-	-	
	stplingam@gmail.com			RDA Reg No. RDASR 0151
4	JKW Technologies	Specilized category / Brands	Business Reg. No	WV/16105
	No.45/T, Kanduboda, Delgoda	-	-	
	0112190214	-	-	
	0112190214	-	-	
	jkwtechnologies@gmail.com			RDA Reg No. RDASR 0246
5	Micro Channel Lanka (Pvt) Ltd	Specilized category / Brands	Business Reg. No	DS/MN/C/BR/764
	No.165D, New Kalmunai, Batticaloa	-	-	
	0762339997/0773201786/0777710086/0765788774	-	-	
	0652224646	-	-	
	info@mclpvt.lk			RDA Reg No. RDASR 0261
6	J Cel	Specilized category / Brands	Business Reg. No	WP19161
	No.140/11, Alubowila, Delgoda	-	-	
	0773081615	-	-	
	-	-	-	
	jcel2021@gmail.com			RDA Reg No. RDASR 0374

2.19 Repairs of Computers Services on Hardware

7	Lakmuthu IT Solutions	Business Reg. No 27/3834						
	St. Mary's rd, Chilaw	Specilized category / Brands						
	0322221210	<table border="1"> <tr> <td>Hikvision</td> <td>-</td> </tr> <tr> <td>-</td> <td>-</td> </tr> <tr> <td>-</td> <td>-</td> </tr> </table>	Hikvision	-	-	-	-	-
Hikvision	-							
-	-							
-	-							
	-							
	office@lakmuthu.com	RDA Reg No. RDASR 0403						
8	K.N.C.Computer Technologies Pvt Ltd	Business Reg. No PV76241						
	No.21 A, Station Rd, Matara	Specilized category / Brands						
	04122342222	<table border="1"> <tr> <td>-</td> <td>-</td> </tr> <tr> <td>-</td> <td>-</td> </tr> <tr> <td>-</td> <td>-</td> </tr> </table>	-	-	-	-	-	-
-	-							
-	-							
-	-							
	0412234222							
	knccomputer@gmail.com	RDA Reg No. RDASR 0653						
9	Metropolitan Technologies (Pvt) Ltd	Business Reg. No Pr9395						
	No.12, Magazine rd, Colombo 08	Specilized category / Brands						
	0114700200	<table border="1"> <tr> <td>Chigo-Air Conditioners</td> <td>er Engineering- Gener</td> </tr> <tr> <td>Acer- Computers</td> <td>lingbo RDC- Piplicator</td> </tr> <tr> <td>Printronix-Printers</td> <td></td> </tr> </table>	Chigo-Air Conditioners	er Engineering- Gener	Acer- Computers	lingbo RDC- Piplicator	Printronix-Printers	
Chigo-Air Conditioners	er Engineering- Gener							
Acer- Computers	lingbo RDC- Piplicator							
Printronix-Printers								
	0114700267							
	salesmal@metropolitan.lk	RDA Reg No. RDASR 0866						
10	SNV Engineering & Constructions (Pvt) Ltd	Business Reg. No PV00203336						
	No.28, Old Kesbewa rd, Delkanda, Nugegoda	Specilized category / Brands						
	0777661524	<table border="1"> <tr> <td>-</td> <td>-</td> </tr> <tr> <td>-</td> <td>-</td> </tr> <tr> <td>-</td> <td>-</td> </tr> </table>	-	-	-	-	-	-
-	-							
-	-							
-	-							
	-							
	snvcommunicationsystems@gmail.com	RDA Reg No. RDASR 0914						
11	Suprim Computers	Business Reg. No R/Kuru/1367						
	C.149/1B, Medawatta,Meneriwatta, Parakaduwa	Specilized category / Brands						
	0714831122/0719498123	<table border="1"> <tr> <td>-</td> <td>-</td> </tr> <tr> <td>-</td> <td>-</td> </tr> <tr> <td>-</td> <td>-</td> </tr> </table>	-	-	-	-	-	-
-	-							
-	-							
-	-							
	-							
	bapfernandoo@gmail.com	RDA Reg No. RDASR 0756						
12	Debug Computer Peripherals (Pvt) Ltd	Business Reg. No PV2347						
	No.58, 42nd Lane, Wellawatta, Colombo 06	Specilized category / Brands						
	0117520000	<table border="1"> <tr> <td>DCP</td> <td>BENQ</td> </tr> <tr> <td>EPSON</td> <td>SOPHOS</td> </tr> <tr> <td>KYOCERA</td> <td></td> </tr> </table>	DCP	BENQ	EPSON	SOPHOS	KYOCERA	
DCP	BENQ							
EPSON	SOPHOS							
KYOCERA								
	0112362612/0112589597							
	corporate@debugisp.net/sanjeewaw2debugisp.net	RDA Reg No. RDASR 0769						

2.19 Repairs of Computers Services on Hardware

13 **i3 Technologies (Pvt) Ltd** Business Reg. No PV83970

Specilized category / Brands

-	-
-	-
-	-

No.30,Kandy Rd, Galugama, Kelaniya

0113692295/0776145149

0113692295

ashleyi3tech@gmail.com

RDA Reg No. RDASR **0918**

14 **E W Information Systems Ltd** Business Reg. No PB719

Specilized category / Brands

Ewis	-
-	-
-	-

No.70, 1st floor, Lucky Plaza Building,
St. Anthony's Mw, Colombo 03

0117520520

0112447303

info@ewisl.net

RDA Reg No. RDASR **0953**

15 **Vanoj Office Automation** Business Reg. No 1767

Specilized category / Brands

Photo copier	Computers
Fax machin	Toner, Cartridge
Laptop	

561/40,Preeman Mw, Anuradhapura

0254580054

0252226900

vanojoffice@gmail.com

RDA Reg No. RDASR **1014**

16 **Sumathi Information Technologies (Pvt) Ltd** Business Reg. No PV417

Specilized category / Brands

Pix4D	-
TRD	-
Rafael Advanced	

No.491, Galle rd, Colombo 03





















0773887013/0115553311

0115553312

info@sit.lk

RDA Reg No. RDASR **1035**

2.20 Repairs of Construction Machinery & Equipment

1	Diesel & Motor Engineering PLC	Business Reg. No	PQ146
	No.65, Jethamana Rd, Colombo 14	Specilized category / Brands	
	0112449797/0112338883	-	-
	0112449080	-	-
	dimo@dimolanka.com	RDA Reg No.	RDASR 0476
2	Ontarc (Pvt) Ltd	Business Reg. No	PV372
	137, Mahena Rd, Siyambalape	Specilized category / Brands	
	0114740954	-	-
	0114740954	-	-
	ontarc@sltnet.lk	RDA Reg No.	RDASR 0489
3	Analytical Instruments (Pvt) Ltd	Business Reg. No	PV1328
	No.100, Elvitigala Mw, Colombo 08	Specilized category / Brands	
	0112639000	-	-
	0112699282	-	-
	analytical@aipi.lk	RDA Reg No.	RDASR 0490
4	Trident Holdings (Pvt) Ltd	Business Reg. No	PV12439
	No.63/1, Maharagama rd, Boraesgamuwa	Specilized category / Brands	
	0112715657	Boreholdrilling Machine	-
	0112150806	Survey Equipments	-
	info@tridentholdings.lk	Core Drilling Accessorie	-
		RDA Reg No.	RDASR 0733
5	N Technology	Business Reg. No	WC10665
	No. 86/3, Kurunduwatta rd, Pitakotte, Kotte	Specilized category / Brands	
	0772966141	-	-
	0113601170	-	-
	info@ntechnology.lk	RDA Reg No.	RDASR 0910

2.21 Repairs of Office Furniture (Wooden and Steel)

1 Sandamali Timber Depot



No.98, Ketapitiya, Menikdiwela



0772449472



-



asith.kodi@gmail.com

Specilized category / Brands

Timber	-
Furniture	-
-	-

Business Reg. MPS/DS/Yanu/3
No 850

RDA Reg No.

RDASR **0696**

2 Sandamali Timber Depot



No.98, Ketapitiya, Menikdiwela



0772449472



-



asith.kodi@gmail.com

Specilized category / Brands

Timber	-
Furniture	-
-	-

Business Reg. MPS/DS/Yanu/3
No 850

RDA Reg No.

RDASR **0696**

3 T.D.R.Engineering and Construction



No.08, Good Shed Rd, Rathnapura



0717850600



0452222118



tdengineeringc@gmail.com

Specilized category / Brands

-	-
-	-
-	-

Business Reg. 3917

RDA Reg No.

RDASR **0817**

2.22 Repairs to Laboratory and Weighing Equipment, Dial Gauges

1 Electroscopes and Equipment



146/11C, Caldera Gardens, Dutugemunu Street, Kohuwela



0112817659/0112818042



0112817658



scales@slt.net.lk

Specilized category / Brands

and Material Testing

types of Electronic Weighing S

-

Business Reg. No W/A 21744

RDA Reg No.

RDASR

0156

2 Ontarc (Pvt) Ltd



137, Mahena Rd, Siyambalape



0114740954



0114740954



ontarc@slt.net.lk

Specilized category / Brands

-

-

-

Business Reg. No PV372

RDA Reg No.

RDASR

0489

3 Analytical Instruments (Pvt) Ltd



No.100, Elvitigala Mw, Colombo 08



0112639000



0112699282



analytical@aipl.lk

Specilized category / Brands

-

-

-





















Business Reg. No PV1328

RDA Reg No.

RDASR

0490

2.23 Security Services

1	Dilco Security and Investigations (Pvt) Ltd	Specilized category / Brands	Business Reg. No	Old-N(PV S0 21106/New-16662						
	 No. 839/C, "Dilco Court", Daham Mw, Malabe	<table border="1"> <tr><td>-</td><td>-</td></tr> <tr><td>-</td><td>-</td></tr> <tr><td>-</td><td>-</td></tr> </table>	-	-	-	-	-	-		
-	-									
-	-									
-	-									
	 0112744333/0717304647									
	 0114542178									
	 dilcosecure@gmail.cm/ majordenet@yahoo.com		RDA Reg No. RDASR 0008							
2	8 Six Guard Security & Investigations (Pvt) Ltd	Specilized category / Brands	Business Reg. No	PV82873						
	 No.65A, Mapanawatura rd, Kandy	<table border="1"> <tr><td>-</td><td>-</td></tr> <tr><td>-</td><td>-</td></tr> <tr><td>-</td><td>-</td></tr> </table>	-	-	-	-	-	-		
-	-									
-	-									
-	-									
	 0773245528									
	 0812215388									
	 8sixguard@gmail.com		RDA Reg No. RDASR 0444							
3	N.L.I.N.Security (Pvt) Ltd	Specilized category / Brands	Business Reg. No	PV104091						
	 No.160/8, Sama Mw, Doowa Junction, Galthude, Panadura	<table border="1"> <tr><td>-</td><td>-</td></tr> <tr><td>-</td><td>-</td></tr> <tr><td>-</td><td>-</td></tr> </table>	-	-	-	-	-	-		
-	-									
-	-									
-	-									
	 0383130028/0718289422									
	 -									
	 nlinservice@gmail.com		RDA Reg No. RDASR 0677							
4	T.D.R.Engineering and Construction	Specilized category / Brands	Business Reg. No	3917						
	 No.08, Good Shed Rd, Rathnapura	<table border="1"> <tr><td>-</td><td>-</td></tr> <tr><td>-</td><td>-</td></tr> <tr><td>-</td><td>-</td></tr> </table>	-	-	-	-	-	-		
-	-									
-	-									
-	-									
	 0717850600									
	 0452222118									
	 tdengineeringc@gmail.com		RDA Reg No. RDASR 0817							
5	Pioneer Security Service (Pvt) Ltd	Specilized category / Brands	Business Reg. No	PV67297						
	 No.75, Awissawella rd, Mahabuthgamuwa, Angoda	<table border="1"> <tr><td>-</td><td>-</td></tr> <tr><td>-</td><td>-</td></tr> <tr><td>-</td><td>-</td></tr> </table>	-	-	-	-	-	-		
-	-									
-	-									
-	-									
	 0112549091									
	 0112549992									
	 info@pioneer.lk		RDA Reg No. RDASR 0841							

2.24 Software Development/Consultancy and Related Services

1 Lithium Technologies



No.506,Kaduwela Rd, Thaladena,
Thalangama, Malabe



011288826/0701817239



0112888286



sales@lithium.lk/janani@lithium.lk

Specilized category / Brands

Business Reg.
No

WD13008

-	-
-	-
-	-

RDA Reg No.

RDASR **0013**

2 Just In Time Technologies (Pvt) Ltd



No.370, 4th Floor, Galle Rd, Colombo 03



0112574083



0112574085



pubudu@jithpl.com/tenders@jithpl.com

Specilized category / Brands

Business Reg.
No

PV5245

-	-
-	-
-	-

RDA Reg No.

RDASR **0141**

3 DMS Software Engineering (Pvt) Ltd



No.380, Koswatta Rd, Kalapaluwawa,
Rajagiriya



0112876700



0112876877



info@dmsse.com

Specilized category / Brands

Business Reg.
No

PV18761

Kaspersky	Imago
Sophos Firewall	HRIS
DMS-Docubinet	

RDA Reg No.

RDASR **0428**

4 Sumathi Information Technologies (Pvt) Ltd



No.491, Galle rd, Colombo 03



0773887013/0115553311



0115553312



info@sit.lk

Specilized category / Brands

Business Reg.
No

























PV417

Pix4D	-
TRD	-
Rafael Advanced	

























RDA Reg No.

RDASR **1035**

2.25 Surveying and Providing the Related Services

1	Suleco (Pvt) Ltd	Business Reg. No PV70495
	No.44, Beddagana South, Pitakotte	
	0112828100	
	0112828100	
	tendering@suleco.lk	
	Specilized category / Brands	
	Laboratory Equipment	-
	Survey Equipment	-
	-	-
	RDA Reg No.	RDASR 0100
2	Gamini B Dodanwela Associates PVT Ltd	Business Reg. No PV17694
	No.213C, 2/2, Anagarika Dharmapala Mw, Dehiwala	
	0112716996/0114205427	
	0114208148	
	gbdaprojects@yahoo.com	
	Specilized category / Brands	
	-	-
	-	-
	-	-
	RDA Reg No.	RDASR 0140
3	Land Management Solution & Consultation (Pvt) Ltd	Business Reg. No PV00227095
	109/A, Embaruluwa North, Weliweriya	
	0716153990	
	(94)453127106	
	surveylmsc@gmail.com	
	Specilized category / Brands	
	-	-
	-	-
	-	-
	RDA Reg No.	RDASR 0172
4	Sunil Kusumsiri Associates (Pvt) Ltd	Business Reg. No PV00212090
	400, Galle Rd, Thalpitiya South, Wadduwa	
	0777582588	
	-	
	sunil_kusumsiri@yahoo.com	
	Specilized category / Brands	
	-	-
	-	-
	-	-
	RDA Reg No.	RDASR 0226
5	R.K.M.R.Karunanayaka	Business Reg. No 19871515
	147, Gewal 55, Buddhagaya Mw, Anuradhapura	
	0252226966/0718101547	
	-	
	karu1960@gmail.com	
	Specilized category / Brands	
	-	-
	-	-
	-	-
	RDA Reg No.	RDASR 0295
6	G.M.K.thennakoon	Business Reg. No 19911655
	Temple Rd, Maha Kekirawa, Kekirawa	
	0252265535/0777451011/0701238182	
	-	
	tennakoongmk@yahoo.com	
	Specilized category / Brands	
	-	-
	-	-
	-	-
	RDA Reg No.	RDASR 0308

2.25 Surveying and Providing the Related Services

7	Prasad Surveys (Pvt) Ltd	Business Reg. No. PV64103
	No.40/1/1, Bandarawtta, atuwawala, oraesgamuwa	Specilized category / Brands
	0112518391/0777323024	-
	0112518391	-
	prasadsurvey.pvt@gmail.com	-
	RDA Reg No.	RDASR 0364
8	P.A.N.De Silva	Business Reg. No. 19831140
	No.9 1/1, 4th Lane, Rathmalana	Specilized category / Brands
	0772642356/0718166209	2.25
	-	-
	panandalal1@gmail.com	-
	RDA Reg No.	RDASR 0382
9	Serendib Survey Engineers	Business Reg. CPC/KY/DS/2/2/6488
	No.47/2, Sirimalwatta, Gunnepana	Specilized category / Brands
	0812470526	-
	-	-
	serendibse@gmail.com	-
	RDA Reg No.	RDASR 0496
10	W.A.A.Pathma Kumara	Business Reg. No. 199616637
	No.1/6, Upatissa Mw, Walgama, Matara	Specilized category / Brands
	0714142625/0412221816	-
	0412221816	-
	apathmakumara@gmail.com	-
	RDA Reg No.	RDASR 0665
11	Instech (Pvt) Ltd	Business Reg. No. PV13494
	72/1, , Carlton Residencies, Pepiliyana rd, Nedimala	Specilized category / Brands
	0117922665	Survey Equipments
	0117922665	Soil Testing Equipment
	instech.trade@gmail.com	GPS
	RDA Reg No.	RDASR 0960
12	Bhoomi Tech (Pvt) Ltd	Business Reg. No. PV16023
	No.184, Hill Street, Dehiwala	Specilized category / Brands
	0112734550/0112734551	Soil Testing Equip.
	0112713088	umen Testing Lab. Equ
	labsales@bhoomitech.com	Concrete Testing Equip.
	RDA Reg No.	RDASR 0961
		phalt Testing Equipme
		phalt Testing Lab. Equ

2.25 Surveying and Providing the Related Services

13 Glabal GIS (Pvt) Ltd

Business Reg. No PV128283



No.58, Pagoda rd, Nugegoda

Specilized category / Brands

Pentax	NAVA
Kolida	Geomax
e-Survey	



0112824877/0113024377



-



solution.globalgis@gmail.com/info@globalgis.lk

RDA Reg No.

RDASR

0965

14 Survey Engineering Co.(Pvt) Ltd

Business Reg. No PV16713



No.15/5, Kuda Edanda rd, Wattala

Specilized category / Brands

-	-
-	-
-	-



0112930692



0112932139



info@survey.lk

RDA Reg No.

RDASR

0967

15 D.N.De Silva

Business Reg. No 20172122



No.344/5, Paragathota, Wethugedara

Specilized category / Brands

-	-
-	-
-	-



0713482366



-



nishshanka@gmail.com

RDA Reg No.

RDASR

0968

2.26 Tailoring Uniforms and Curtain Material

1 Five Stare Textiles Centre



No.95, second Cross Street, Colombo
11



0112441810/0112345280



0112345184



sstarcurtains@gmail.com

Specilized category / Brands

Specilized category / Brands	Business Reg. No
-	-
-	-
-	-

























Business Reg. No W/A6654

RDA Reg No.

RDASR

0024

























2.27 Tinkering, Painting and Welding Repair Works for Vehicle & Machinery

1	D.M.Auto Spare Spares (Pvt) Ltd	Business Reg. No PV9356
	No.334/108, Main Street, Anuradhapura	
	0252223622	
	-	
	dmqutospares@gmail.com	
	Specilized category / Brands	
	-	-
	-	-
	-	-
	RDA Reg No.	RDASR 0023
2	Deepthi Motors (Pvt) Ltd	Business Reg. No PV17909
	334/108, Main Street, Anuradhapura	
	0252222770	
	0252223476	
	deepthi_mot@yahoo.com	
	Specilized category / Brands	
	-	-
	-	-
	-	-
	RDA Reg No.	RDASR 0073
3	J.D.Rusiru Kavinda	Business Reg. No WC21380
	No.43/42, Walauwawatta Rd, Gangodawila, Nugegoda	
	0717581834	
	-	
	samanaleemotorengineers@gmail.com	
	Specilized category / Brands	
	-	-
	-	-
	-	-
	RDA Reg No.	RDASR 0111
4	Ananda Motors	Business Reg. No WC4799
	61/1, Sigera Rd, Madiwela, Kotte	
	0444674275/0112799654	
	-	
	dinukanavod06@gmail.com	
	Specilized category / Brands	
	-	-
	-	-
	-	-
	RDA Reg No.	RDASR 0112
5	Autoshine (Pvt) Ltd	Business Reg. No PV20478
	174/1, Old Kesbewa Rd, Delkanda, Nugegoda	
	0115548648	
	0112819809	
	autoshine88@gmail.com	
	Specilized category / Brands	
	-	-
	-	-
	-	-
	RDA Reg No.	RDASR 0173
6	G.N.J. Auto Motors	Business Reg. No W78511
	No.1040/1/J, Pothuarawa Rd, Malabe	
	0777033740/0770753833	
	0112562362	
	gnjautomotors@gmail.com	
	Specilized category / Brands	
	-	-
	-	-
	-	-
	RDA Reg No.	RDASR 0194

2.27 Tinkering, Painting and Welding Repair Works for Vehicle & Machinery

7	Ceylon Motor Works Services (Pvt) Ltd	Business Reg. No PV5380								
	No.761/1, Kandy Rd, Kelaniya	<table border="1"> <thead> <tr> <th colspan="2">Specilized category / Brands</th> </tr> </thead> <tbody> <tr><td>-</td><td>-</td></tr> <tr><td>-</td><td>-</td></tr> <tr><td>-</td><td>-</td></tr> </tbody> </table>	Specilized category / Brands		-	-	-	-	-	-
Specilized category / Brands										
-	-									
-	-									
-	-									
	0112917207									
	0112914834									
	info@ceylonmotorworks.com	RDA Reg No. RDASR 0236								
8	Sishan Auto Repairs (Pvt) Ltd	Business Reg. No PV74814								
	No.483/4, Main Street, Kaduwela	<table border="1"> <thead> <tr> <th colspan="2">Specilized category / Brands</th> </tr> </thead> <tbody> <tr><td>-</td><td>-</td></tr> <tr><td>-</td><td>-</td></tr> <tr><td>-</td><td>-</td></tr> </tbody> </table>	Specilized category / Brands		-	-	-	-	-	-
Specilized category / Brands										
-	-									
-	-									
-	-									
	0112537571/0112539065									
	0112539067									
	sishanautorepair@gmail.com	RDA Reg No. RDASR 0260								
9	Jayantha Motors and Fiber Glass	Business Reg. No WP7021								
	No.50, Jaya Mw, Battaramulla	<table border="1"> <thead> <tr> <th colspan="2">Specilized category / Brands</th> </tr> </thead> <tbody> <tr><td>-</td><td>-</td></tr> <tr><td>-</td><td>-</td></tr> <tr><td>-</td><td>-</td></tr> </tbody> </table>	Specilized category / Brands		-	-	-	-	-	-
Specilized category / Brands										
-	-									
-	-									
-	-									
	0719171080									
	-									
	jayanthamotors2020@gmail.com	RDA Reg No. RDASR 0273								
10	Karmart Engineers	Business Reg. No WC8823								
	No.128, Madiwela Rd, Embuldeniya	<table border="1"> <thead> <tr> <th colspan="2">Specilized category / Brands</th> </tr> </thead> <tbody> <tr><td>-</td><td>-</td></tr> <tr><td>-</td><td>-</td></tr> <tr><td>-</td><td>-</td></tr> </tbody> </table>	Specilized category / Brands		-	-	-	-	-	-
Specilized category / Brands										
-	-									
-	-									
-	-									
	0772678567/0712182425									
	-									
	karmart431@gmail.com	RDA Reg No. RDASR 0274								
11	Neo Tech Motors & Service	Business Reg. No W/206312								
	No.23/1/A,Main Street, Battaramulla	<table border="1"> <thead> <tr> <th colspan="2">Specilized category / Brands</th> </tr> </thead> <tbody> <tr><td>-</td><td>-</td></tr> <tr><td>-</td><td>-</td></tr> <tr><td>-</td><td>-</td></tr> </tbody> </table>	Specilized category / Brands		-	-	-	-	-	-
Specilized category / Brands										
-	-									
-	-									
-	-									
	0112887998									
	-									
	neotechmotorslk@gmail.com	RDA Reg No. RDASR 0275								
12	New Acts Auto Engineers	Business Reg. No WDE000032								
	No.807/B/2, Kandawatta Rd, Pelawatta, Battaramulla	<table border="1"> <thead> <tr> <th colspan="2">Specilized category / Brands</th> </tr> </thead> <tbody> <tr><td>-</td><td>-</td></tr> <tr><td>-</td><td>-</td></tr> <tr><td>-</td><td>-</td></tr> </tbody> </table>	Specilized category / Brands		-	-	-	-	-	-
Specilized category / Brands										
-	-									
-	-									
-	-									
	0770125005/0112824444									
	-									
	gemunub@yahoo.com	RDA Reg No. RDASR 0363								

2.27 Tinkering, Painting and Welding Repair Works for Vehicle & Machinery

13	Shan Motors	Business Reg. No. W/A81170
	45/H, Cemetri Rd, Battaramulla	
	0773603373	
	-	
	prasanna741022@gmail.com	
	Specilized category / Brands	
	-	-
	-	-
	-	-
	RDA Reg No.	RDASR 0481
14	Monaragala Motors (PVT) Ltd	Business Reg. No. PV00247282
	Kumara Dola Rd, Monaragala	
	0552276757	
	0552276757	
	monaragalamotors1@gmail.com	
	Specilized category / Brands	
	-	-
	-	-
	-	-
	RDA Reg No.	RDASR 0554
15	Bethmage Group	Business Reg. No. 3/u/60/2017-05-17/30
	No.04, Dammulla Junction, Dammulla, Beliatta	
	0472243598/0716005952/0703647263	
	-	
	bethmage86@gmail.com	
	Specilized category / Brands	
	-	-
	-	-
	-	-
	RDA Reg No.	RDASR 0673
16	Saliya Motors	Business Reg. No. 20/0623
	300/1, Kandy Rd, Millawa, Kurunegala	
	0372222447	
	0372222893	
	saliyamotors7@gmail.com	
	Specilized category / Brands	
	-	-
	-	-
	-	-
	RDA Reg No.	RDASR 0827
17	Weligama Motors	Business Reg. No. W99226
	536/C, Amaragoda Rd, Hokandara	
	0728085620	
	0112776009	
	weligama.motorsh@gmail.com	
	Specilized category / Brands	
	-	-
	-	-
	-	-
	RDA Reg No.	RDASR 0875
18	Saman Auto Electricals	Business Reg. No. W65363
	771/1, Pannipitiya rd, Thalawathugoda	
	0777474721	
	0112776000	
	saman721auto@gmail.com	
	Specilized category / Brands	
	-	-
	-	-
	-	-
	RDA Reg No.	RDASR 0879

2.27 Tinkering, Painting and Welding Repair Works for Vehicle & Machinery

19 **Chaminda Motors** Business Reg. No 3643

Specilized category / Brands

-	-
-	-
-	-

 135 B, Depanama, Pannipitiya

 0785608678

 -

 poornithathsaranigamage@gmail.com

RDA Reg No. RDASR **0785**

20 **Vindeev Auto (Pvt) Ltd** Business Reg. No PV62014

Specilized category / Brands

-	-
-	-
-	-

 Highlaval rd, Kottawa, Pannipitiya

 0113031710/0773172734

 0112838875

 vindeevauto@yahoo.com

RDA Reg No. RDASR **0917**

21 **Vikasitha Enterprises (Pvt) Ltd** Business Reg. No PV912/24/10/2007

Specilized category / Brands

-	-
-	-
-	-

 No.225, High Level rd, Galawilawatta, Homagama

 0772518657

 0112748429

 sales.vikasitha@gmail.com

RDA Reg No. RDASR **0988**

22 **Delta Motor Engineers** Business Reg. No W/C 6738

Specilized category / Brands

-	-
-	-
-	-

 272/B, Hokandara Rd, Thalawathugoda

























 0112773723

 0112773723

























 sunithravi6@gmail.com

RDA Reg No. RDASR **1001**

2.28 Uphollstery Work Including Seat Covers

1	Sathuta Industries (Pvt) Ltd	Business Reg. No. PV89382
	No.2/1/A,Dewamithyha Place, Heyyanthuduwa	Specilized category / Brands
	0753734244, 0753734272	-
	0112082845	-
	contact@sathutaindustries.lk	-
	RDA Reg No.	RDASR 0326
2	D.M.Auto Spare Spares (Pvt) Ltd	Business Reg. No. PV9356
	No.334/108, Main Street, Anuradhapura	Specilized category / Brands
	0252223622	-
	-	-
	dmqutospares@gmail.com	-
	RDA Reg No.	RDASR 0023
3	Onil Motors	Business Reg. No. WP2473
	673/K, Kandawatta, Thalangama south, Battaramulla, 5th lane	Specilized category / Brands
	0112785991/0770556379	-
	-	-
	onilprasanna@gmail.com	-
	RDA Reg No.	RDASR 0105
4	Gamage Cusion Works	Business Reg. No. WJ5009
	No.163, Kesbewa rd, Katuwawala, Boralesgamuwa	Specilized category / Brands
	0112218339	-
	0112519339	-
	sumalgamage2@gmail.com	-
	RDA Reg No.	RDASR 0171
5	Ceylon Motor Works Services (Pvt) Ltd	Business Reg. No. PV5380
	No.761/1, Kandy Rd, Kelaniya	Specilized category / Brands
	0112917207	-
	0112914834	-
	info@ceylonmotorworks.com	-
	RDA Reg No.	RDASR 0236
6	Sathuta Industries (Pvt) Ltd	Business Reg. No. PV89382
	No.2/1/A,Dewamithyha Place, Heyyanthuduwa	Specilized category / Brands
	0753734244, 0753734272	-
	0112082845	-
	contact@sathutaindustries.lk	-
	RDA Reg No.	RDASR 0326

2.28 Uphollstery Work Including Seat Covers

7	NV Auto Engineers	Business Reg. No. WD16307
	No.308/2, Kaduwela Road, Thalangama North, Koswatta, Battaramulla	Specilized category / Brands
	0778565814, 0112078035	-
	0112093950	-
	nvautoengineers@gmail.com	-
	RDA Reg No.	RDASR 0327
8	Weligama Motors	Business Reg. No. W99226
	536/C, Amaragoda Rd, Hokandara	Specilized category / Brands
	0728085620	-
	0112776009	-
	weligama.motorsh@gmail.com	-
	RDA Reg No.	RDASR 0875
9	Nadun Cushion works	Business Reg. No. W67849
	40/1, Wanatha Rd, Gangodawila, Nugegoda	Specilized category / Brands
	0115288421	-
	0112803105	-
	naduncushion@gmail.com	-
	RDA Reg No.	RDASR 0877
10	Saman Auto Electricals	Business Reg. No. W65363
	771/1, Pannipitiya rd, Thalawathugoda	Specilized category / Brands
	0777474721	-
	0112776000	-
	saman721auto@gmail.com	-
	RDA Reg No.	RDASR 0879
11	Vindeev Auto (Pvt) Ltd	Business Reg. No. PV62014
	Highlaval rd, Kottawa, Pannipitiya	Specilized category / Brands
	0113031710/0773172734	-
	0112838875	-
	vindeevauto@yahoo.com	-
	RDA Reg No.	RDASR 0917
12	Gunawardana Cushion House (Pvt) Ltd	Business Reg. No. PV8787
	No.485, Highlevel rd, Gangodawila, Wijerama, Nugegoda	Specilized category / Brands
	0112802045	-
	0112801115	-
	gunawardanacushion@gmail.com	-
	RDA Reg No.	RDASR 0941

2.28 Uphollstery Work Including Seat Covers

13 **Ketaka Cushion House (Pvt) Ltd**



No.548, Highlevel rd, Gangodawila,
Nugegoda



0115231857



0114303060



ketakahouse@ymail.com

Specilized category / Brands

-	-
-	-
-	-

Business Reg.
No

PV21917

RDA Reg No.

RDASR **0944**

14 **Chaminda Cushion Works Pvt Ltd**



635, Highlevel rd, Gangodawila, Nugegoda



0115231957



0112801018



chamindcushion@yahoo.com

Specilized category / Brands

-	-
-	-
-	-

Business Reg.
No

PV68824

RDA Reg No.

RDASR **0945**

15 **Vikasitha Enterprises (Pvt) Ltd**



No.225, High Level rd, Galawilawatta,
Homagama



0772518657



0112748429



sales.vikasitha@gmail.com

Specilized category / Brands

-	-
-	-
-	-

Business Reg.
No

PV912/24/10/20
07

RDA Reg No.

RDASR **0988**

2.29 Wharf Clearing, Transport and Delivery of Imported Goods

1 #N/A



#N/A



#N/A



#N/A



#N/A

Specilized category / Brands

Business Reg.
No

#N/A

#N/A	#N/A
#N/A	#N/A
#N/A	

RDA Reg No.

RDASR -

2.30 Pest Control

Abans Environmental Services

1 (Pvt) Ltd



No.141, Kirola Rd, Colombo 05



0117717777



0112369555



info@abansiss.com

Specilized category / Brands

Specilized category / Brands	Business Reg. No
-	-
-	-
-	-

Business Reg. No PV8796

RDA Reg No.

RDASR 0115

Ultrakil Pest Management Co. (Pvt)

2 Ltd



188/1A, Peter D. Perera Mw, Kohuwala



0114516161



0114201399



info@ultrakil.lk

Specilized category / Brands



Specilized category / Brands	Business Reg. No
-	-
-	-
-	-

Business Reg. No PV95329

RDA Reg No.

RDASR 0454

2.31 Translation (In Sinhala, Tamil and English)

1	#N/A		Specilized category / Brands	Business Reg. No	#N/A					
	#N/A		<table border="1"><tr><td>#N/A</td></tr><tr><td>#N/A</td></tr><tr><td>#N/A</td></tr></table>	#N/A	#N/A	#N/A	<table border="1"><tr><td>#N/A</td></tr><tr><td>#N/A</td></tr></table>	#N/A	#N/A	
#N/A										
#N/A										
#N/A										
#N/A										
#N/A										
	#N/A									
	#N/A									
	#N/A			RDA Reg No.	<table border="1"><tr><td>RDASR -</td></tr></table>	RDASR -				
RDASR -										

2.32 Under Water Investigation and Related Services

1 #N/A



#N/A



#N/A



#N/A



#N/A

Specalized category / Brands

#N/A
#N/A
#N/A

#N/A
#N/A

Business
Reg. No

#N/A

RDA Reg No.

RDASR -

2.33 Document Scanning Services (Type A0- to A4)

1 DMS Software Engineering (Pvt) Ltd

 No.380, Koswatta Rd, Kalapaluwawa,
Rajagiriya

 0112876700

 0112876877

 info@dmsswe.com

Specilized category / Brands

Kaspersky	Imago
Sophos Firewall	HRIS
DMS-Docubinet	

Business Reg. No PV18761

RDA Reg No.

RDASR	0428
-------	------